

# FURUNO

# OPERATOR'S MANUAL

INMARSAT-C  
MOBILE EARTH STATION

---

MODEL      FELCOM 12

---



**FURUNO ELECTRIC CO., LTD.**  
NISHINOMIYA, JAPAN

© **FURUNO ELECTRIC CO., LTD.**

9-52, Ashihara-cho,  
Nishinomiya, Japan

Telephone: 0798-65-2111  
Telefax: 0798-65-4200

•Your Local Agent/Dealer

All rights reserved. Printed in Japan

FIRST EDITION : NOV. 1997  
M2 : JAN. 22, 2003

(YOSH) PUB. No. OME-56130  
FELCOM 12



\* 00080808701 \*



\* OME56130M20 \*



# SAFETY INSTRUCTIONS

## **WARNING**



### **Do not open the equipment.**

Hazardous voltage which can cause electrical shock, burn or serious injury exists inside the equipment. Only qualified personnel should work inside the equipment.



### **Hazardous microwave. Do not approach within 60 cm of the antenna radome when it is transmitting.**

Microwave radiation can be harmful to the human body, particularly the eyes.

Radiation Level	At
10W/m <sup>2</sup>	60 cm

### **Leave the equipment powered while underway.**

Distress cannot be communicated unless the equipment is powered.

### **Do not disassemble or modify the equipment.**

Fire, electrical shock or serious injury can result.

### **Turn off the power immediately if water leaks into the equipment or the equipment is emitting smoke or fire.**

Continued use of the equipment can cause fire or electrical shock.

### **Do not place liquid-filled containers on the top of the equipment.**

Fire or electrical shock can result if a liquid spills into the equipment.

## **WARNING**

### **Do not operate the equipment with wet hands.**

Electrical shock can result.

### **Keep heater away from equipment.**

Heat can alter equipment shape and melt the power cord, which can cause fire or electrical shock.

### **Any repair work must be done by a licensed radio technician.**

Improper repair work can cause electrical shock or fire.

## **CAUTION**

### **Use the proper fuse.**

Use of a wrong fuse can result in fire or permanent equipment damage.

### **Do not use the equipment for other than its intended purpose.**

Personal injury can result if the equipment is used as a chair or stepping stool, for example.

### **Do not place objects on the top of the equipment.**

The equipment can overheat or personal injury can result if the object falls.

## WARNING Label attached



Name: Warning Label

Type: 16-013-2013-1

Code No.: 100-251-640

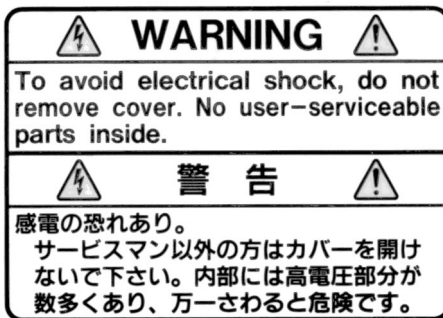
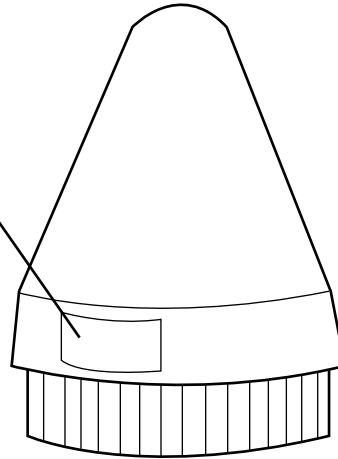

Name: Warning Label(1)

Type: 16-003-1011-0

Code No.: 100-236-230

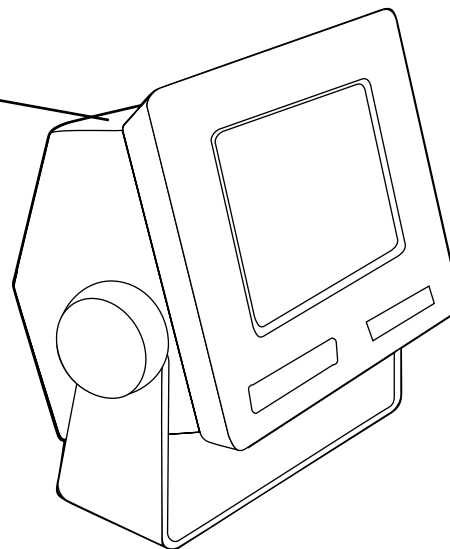

# CONTENTS

---

<b>MENU TREE .....</b>	<b>vii</b>
<b>OPERATIONAL OVERVIEW .....</b>	<b>viii</b>
<b>PROGRAM NUMBER .....</b>	<b>ix</b>
<b>FOREWORD .....</b>	<b>1</b>
Introduction .....	1
Features .....	2
About This Manual .....	3
FELCOM 12 System Configuration .....	4
<b>INMARSAT-C SYSTEM .....</b>	<b>5</b>
Introduction .....	5
Inmarsat System Configuration .....	6
Communications Network .....	9
Types of MES .....	10
Peripheral Equipment .....	11
Distress/Urgent Receiving Call Unit (IC-303) .....	11
Distress Alert Unit (IC-302) .....	11
Distress Message Controller (DMC-5: Option).....	11
<b>OPERATIONAL OVERVIEW .....</b>	<b>1-1</b>
The Communication Unit .....	1-1
Self test .....	1-1
When the audible alarm sounds .....	1-1
The Terminal Unit.....	1-2
Floppy disk drive .....	1-2
Floppy disk .....	1-2
Printer PP-510 (optional supply) .....	1-3
Keyboard .....	1-4
Key description .....	1-4
Shortcut key operation .....	1-6
Function Menus .....	1-6
Selecting menu, menu options .....	1-7
Function menu description .....	1-7
Sample menu operation .....	1-8
Display Indications .....	1-9
Error Messages and Alerts .....	1-11
Silencing the Audible Alarm.....	1-12
Silencing the alarm by the Setup menu .....	1-12
Using a Personal Computer as a Terminal Unit .....	1-13
PC requirements .....	1-13
Installing the program.....	1-13
Contents of program disk .....	1-14

## **SYSTEM INITIALIZATION .....2-1**

System Settings.....	2-1
Two sets of DTEs installed.....	2-1
System setup.....	2-2
Terminal Setup.....	2-6
Login and Logout.....	2-7
Login.....	2-8
Logout.....	2-9
EGC Settings.....	2-11
What is the EGC (Enhanced Group Call) service?.....	2-11
EGC setup.....	2-12
Programming EGC channels.....	2-15
Programming NCS Channels.....	2-16
LES List Operations.....	2-18
Programming the LES list.....	2-18
Deleting and changing the LES list.....	2-20
Printing the LES list.....	2-20
Station List Operations.....	2-22
Programming the station list.....	2-22
Editing the station list.....	2-25
Printing the station list.....	2-25
Entering Own Ship's Position.....	2-26
Setting Directories.....	2-27
E-mail Service List.....	2-28
E-mail Setup.....	2-30

## **FILE OPERATIONS .....3-1**

Preparing a Message.....	3-1
Preparing a routine message.....	3-1
Preparing a confidential message.....	3-2
Editor menu setup.....	3-3
Cutting and pasting text.....	3-4
Copying and pasting text.....	3-5
Insert (with Citation).....	3-6
Select All.....	3-6
Search and Replace.....	3-6
Go to line.....	3-6
Time or Pos. ins.....	3-6
Saving a Message.....	3-7
Formatting a floppy disk.....	3-7
Saving a message.....	3-8
Opening a File.....	3-10
Opening a file.....	3-10
Switching between files.....	3-11
Opening a file where a working area is occupied.....	3-11
Saving a File Under a New Name.....	3-12
Printing a File.....	3-13
Combining Files.....	3-14
Deleting a File.....	3-14
MIME (Multipurpose Internet Mail Extensions).....	3-15
Rename.....	3-16

<b>INMARSAT-C COMMUNICATIONS .....</b>	<b>4-1</b>
Transmitting .....	4-1
Code description .....	4-1
Transmitting prepared message .....	4-2
Transmitting message stored on floppy disk (multiple address) .....	4-9
Canceling transmission .....	4-13
Confirming delivery status (message status list) .....	4-14
Manually requesting delivery status .....	4-16
The 2-digit code services .....	4-17
Inserting the destinations of a fax terminal .....	4-19
Receiving .....	4-20
When a message is received .....	4-20
Setting the receive alarm .....	4-21
Displaying receive messages .....	4-22
Printing receive messages .....	4-23
Saving receive messages to a floppy disk .....	4-24
Automatically saving receive messages .....	4-24
Deleting receive messages .....	4-25
Distress/Urgent Receiving Call Unit IC-303 .....	4-26
Display Log .....	4-26
Displaying and printing the display log .....	4-26
Automatic printing of display log .....	4-27
Display send message log or receive message log .....	4-28
EGC Messages .....	4-28
Displaying and reprinting EGC messages .....	4-28
Displaying EGC closed network ID (ENID) .....	4-29
Receiving EGC distress or urgent message .....	4-30
Tx Message Example Printout .....	4-30
<b>DATA REPORTING AND POLLING .....</b>	<b>5-1</b>
Data Reporting .....	5-1
Setting a data report .....	5-1
Setting a message report .....	5-4
Polling .....	5-6
Polling command .....	5-6
Other polling command .....	5-7
Polling reception .....	5-8
DNID (Data Network Identification) .....	5-9
Displaying DNID .....	5-9
Enabling/Disabling DNID .....	5-10
<b>DISTRESS ALERT .....</b>	<b>6-1</b>
Preparing a Distress Alert .....	6-1
Transmitting a Distress Alert .....	6-3
Testing Distress Button .....	6-4
Distress Communications .....	6-5

**OTHER FUNCTIONS ..... 7-1**

Aborting an Operation ..... 7-1  
Scanning NCS ..... 7-2  
Selecting EGC Receiving Channel ..... 7-3  
Selecting NCS Channel ..... 7-4

**MAINTENANCE ..... 8-1**

Safety Information ..... 8-1  
General Checking and Maintenance ..... 8-2  
    Cleaning the terminal unit and communication unit ..... 8-2  
    Checking connectors and earth terminal ..... 8-2  
    Floppy disk drive head ..... 8-2  
    When the power can't be turned on (power lamp does not light) ..... 8-2  
Self Tests ..... 8-3  
    Self test at power application (communication unit) ..... 8-3  
    Testing the communication unit through the keyboard ..... 8-3  
Performance Verification (PV) Test ..... 8-4  
    PV test sequence ..... 8-4  
    PV test procedure ..... 8-5  
    Results of PV test ..... 8-6  
System Status Monitor ..... 8-7  
    Interpreting the system status monitor ..... 8-8  
Replacing Internal Battery ..... 8-9  
Error Messages ..... 8-10

**SPECIFICATIONS ..... SP-1**

**APPENDIX ..... AP-1**

International Telex/Telephone Country Code List ..... AP-1  
International Telex Abbreviations ..... AP-9  
Glossary of Acronyms ..... AP-10  
International Telegraphy Alphabet ..... AP-11  
Error Messages and Alerts ..... AP-12  
LES IDs List ..... AP-15  
Digital Interface (IEC 61162-2) ..... AP-16

**INDEX ..... IN-1**

**Declaration of conformity to type**



# MENU TREE

Numerals in parenthesis are page numbers.

## F1: File

- 1: New ALT-N (3-1)
- 2: Open ALT-O (3-10)
- 3: Close ALT-Q (3-9)
- 4: Save ALT-S (3-12)
- 5: Delete ALT-D (3-14)
- 6: Rename (3-16)
- 7: Print ALT-P (3-13)
- 8: Format Disk (3-7)(IB-581only)
- 9: MIME (Decode) (3-15)
- 9: QUIT (PC only)

## F2: Edit

- 1: Cut DEL (3-4)
- 2: Copy ALT-C (3-5)
- 3: Paste INS (3-5)
- 4: Insert (with Citation) (3-6)
- 5: Select All ALT-A (3-6)
- 6: Search or Replace (3-6)
- 7: Go to line
  - 1: Top of Text Fn← (3-6)
  - 2: End of Text Fn→ (3-6)
  - 3: Go to Line (3-6)
- 8: Time or Pos. Ins (3-6)
- 9: Change Window ALT-V (3-11)

## F3: Transmit

- 1: Transmit Message (4-2, 4-9)
- 2: Cancel (4-13)
- 3: Request Delivery Status (4-14)

## F4: EGC

- 1: Display EGC Message (4-28)
- 2: EGC Network ID (4-29)

## F5: Reports

- 1: Data Report (5-1)
- 2: Message Report (5-4)
- 3: Date Network ID (5-8)

## F6: Logs

- 1: Send Message Log (4-28)
- 2: Receive Message Log (4-22)
- 3: EGC Log (4-28)
- 4: Log (4-26)

## F7: Options

- 1: Login (2-7)
- 2: Logout (2-9)
- 3: Abort (7-1)
- 4: Select NCS (7-4)
- 5: Ocean Region (7-2)
- 6: Test (6-4, 8-3)

## F8: Setup

- 1: Distress Alert Setup (6-1)
- 2: System Setup (2-2)
- 3: Editor Setup (3-3)
- 4: Terminal Setup (2-1)
- 5: EGC Setup (2-11)
- 6: Auto Mode Setup (4-21, 4-24, 4-27)
- 7: E-Mail Setup (2-30)
- 8: Directories (2-27)
- 9: Configuration
  - 1: Station List (2-22, 2-25)
  - 2: LES List (2-20, 2-18)
  - 3: EGC Channel List (2-15, 7-3)
  - 4: NCS Channel List (2-16)
  - 5: E-Mail Service List (2-28)

F9: Position (2-26)

F10: Stop Alarm (1-1)

# OPERATIONAL OVERVIEW

---

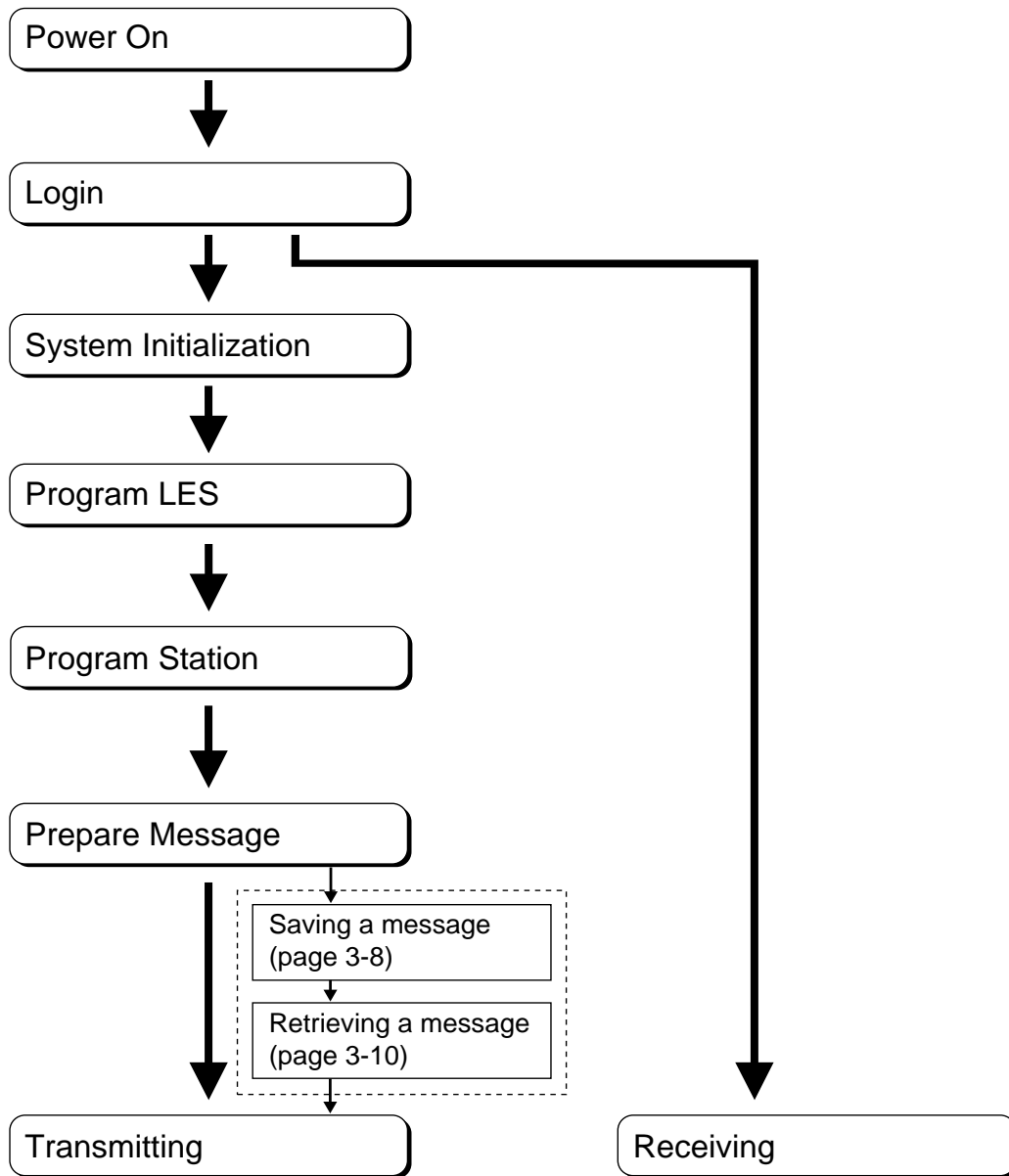

The FELCOM 12 should be turned on for the duration of a voyage.  
Be sure to logout with Inmarsat-C system before turning off the equipment.

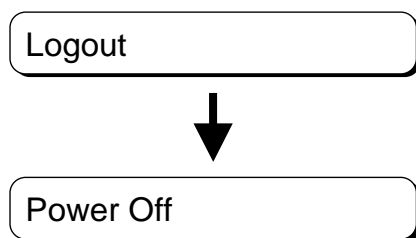

# ***PROGRAM NUMBER***

---

<b>Pub No. Reason for Modification, Date</b>	<b>Software Program No.</b>
OME-56130-K Modified to conform with IEC 61162-1 Edition 2 2002/4	CPU1 165-0112-003 (1998/3) DEMOM 165-0114-003 (1998/3) CPU2 165-0118-014 (2002/4) TERMINAL 165-0116-006 (2000/4)

This page is intentionally left blank.

## Introduction

FURUNO Electric Company thanks you for considering and purchasing the FELCOM 12 Inmarsat-C Mobile Earth Station. We are confident you will discover why the FURUNO name has become synonymous with quality and reliability.

Mainly consisting of an antenna unit, a communication unit and terminal unit, the FELCOM 12 provides the full range of distress and general communication services for mobile and fixed terrestrial subscribers in the Inmarsat-C communication network. Its compact size permits installation where space is limited.

FURUNO designs and manufactures this equipment with much attention to operation and maintenance simplicity. However, please read and follow the recommended procedures for operation and maintenance to get the most out of the equipment.

This manual provides a brief introduction to the Inmarsat-C system (pages 5 thru 10). For more detailed information, however, please refer to "Inmarsat-C Maritime User's Manual" published by Inmarsat. (It is free of charge.) Below are contact points for Inmarsat.

*Inmarsat-C Maritime Customer Relations Officer  
Maritime Services Operations Department  
International Maritime Satellite Organization (Inmarsat)*

*Address: 99 City Road, London EC1Y 1AX, UK*

*Telephone: +44 71 728 1000 (Switchboard)*

*Fax: +44 71 728 1192*

*Telex: 297201 Inmarsat G*

# Features

- Conforms to the following standards: IMO A.807(19), MSC. 68(68), Annex 4, IMO A.694(17), IEC 61097-4 (1994), IEC 60945 (1996), IEC 61162-1 (2000)
- E-mail facility  
To transmit E-mail, register with the LES provider. E-mail charges are calculated separately.
- Built in Enhanced Group Call (EGC) receiver permits operation as EGC-only receiver.
- Communication unit accepts a wide variety of peripheral equipment, Distress Message Controller (DMC), personal computer and remote panel.
- Connection of 2nd Data Terminating Equipment (DTE) for operation from remote location such as the bridge
- Store-and-forward telex communication (public telex network)
- Data reporting and Polling
- Internal GPS receiver (option) in the communication unit provides GPS-generated position.
- Self test programs for maintenance
- Terminal unit provides floppy disk drive for unlimited storage of received and transmitted messages on floppy disks.
- Menu driven operation

# About This Manual

A word about the organization of this manual: It is laid out in a user-friendly manner as possible. We realize a machine like this with its many, many functions can be a little intimidating to even the experienced MES operator. This is why we have arranged this manual in a series of sections that start at a basic level and proceed forward in complexity in a logical manner.

The best way to acquaint yourself with the many facilities this equipment has to offer is to turn it on and try keying in the examples provided in each of the sections. In hardly no time at all you'll be enjoying the benefits of the Inmarsat-C system.

**Inmarsat-C System** This chapter explains the Inmarsat-C system.

**Operational Overview** This chapter introduces basic operations.

**System Initialization** Read this chapter to learn how to initialize the FELCOM 12.

**File Operations** You will learn how to use the text editor in this chapter, to prepare, edit and save messages.

**Inmarsat-C Communications** Read this chapter to learn how to transmit and receive in the Inmarsat-C system.

**Data Reporting and Polling** This chapter explains data reporting setting and polling reception.

**Distress Alert** This chapter tells you how to prepare and transmit the distress alert, and conduct distress communications.

**Other Functions** This chapter describes how to abort operation, scan NCS, and select various channels.

**Maintenance** The maintenance chapter presents information for keeping the FELCOM 12 in top operating condition.

**Appendix** The Appendix presents international telex country codes, international telex abbreviations, glossary of acronyms, error messages and alerts, and international telegraphy alphabet.

# FELCOM 12 System Configuration

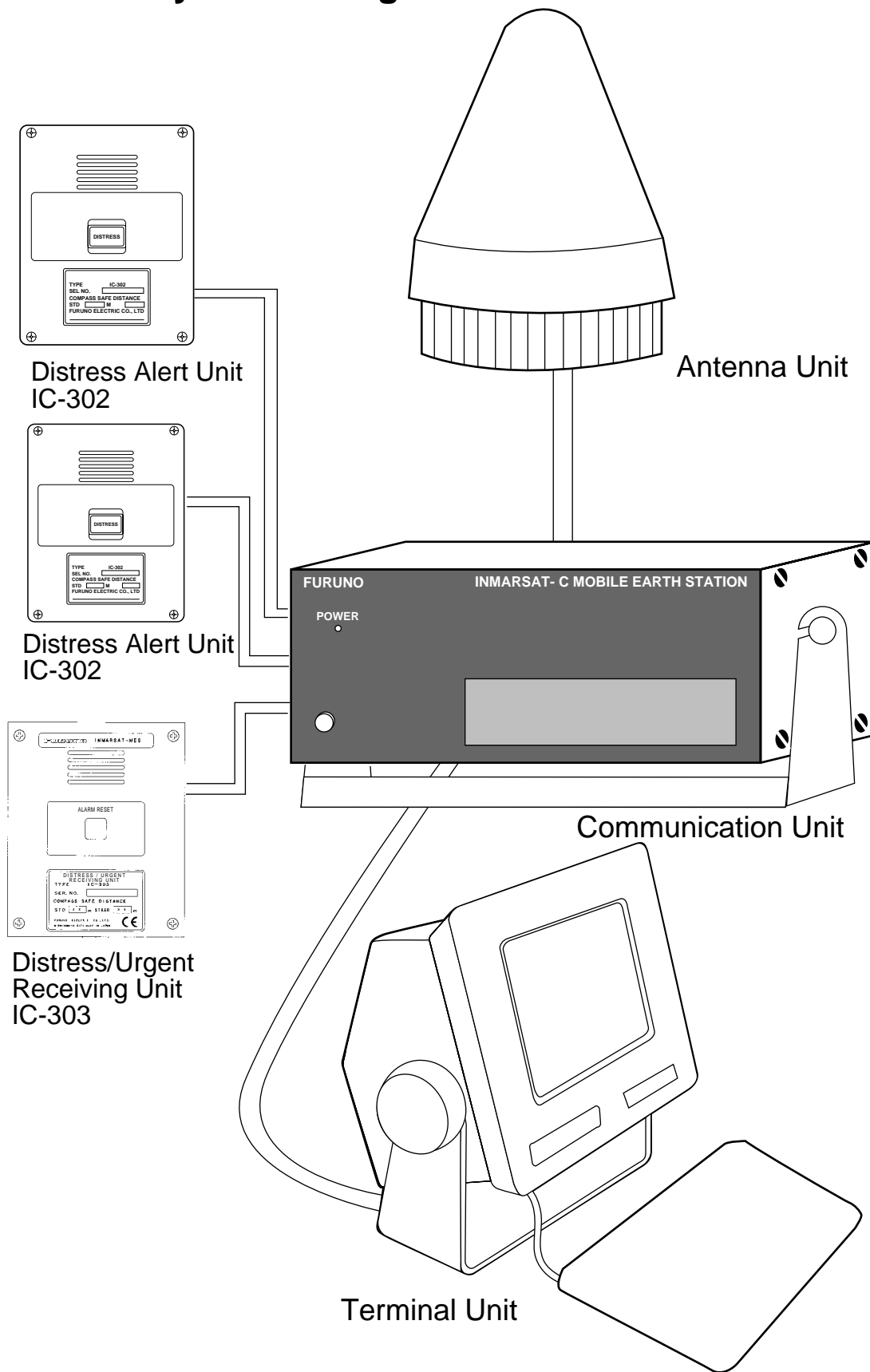

Figure 1 FELCOM 12 system configuration



# INMARSAT-C SYSTEM

---

This chapter provides an overview of the Inmarsat-C satellite communication system.

## Introduction

The Inmarsat-C system provides worldwide telex and data transmission and reception of written information to owners of an Inmarsat-C transceiver or a terrestrial telex network via satellite.

Communication mode is store-and-forward telex, which means all information sent are first stored at a LES and then delivered to designated party.

An EGC (Enhanced Group Call) receiver is built in the FELCOM 12 to receive the following types of messages, broadcast from a LES:

- SafetyNET™-governments and maritime authorities can use this service to distribute maritime safety information to ships within selected areas.
- FleetNET™-commercial subscription organizations or shipping companies can use this service to transmit trade information (for example, company news or market prices) simultaneously to a selected group of ships, to provide up-to-the-minute information.

FELCOM 12 allows you to make *distress calls* which are given immediate priority over all other calls, and are automatically routed to a land-based *Rescue Co-ordination Centre (RCC)*.

Besides its primary application of ship-shore, shore-ship or ship-ship communications, the Inmarsat-C service has also proved beneficial to trucking firms who have found it indispensable for communicating with their vehicles. In this manual, however, we will concentrate on ship applications, the main application.

# Inmarsat System Configuration

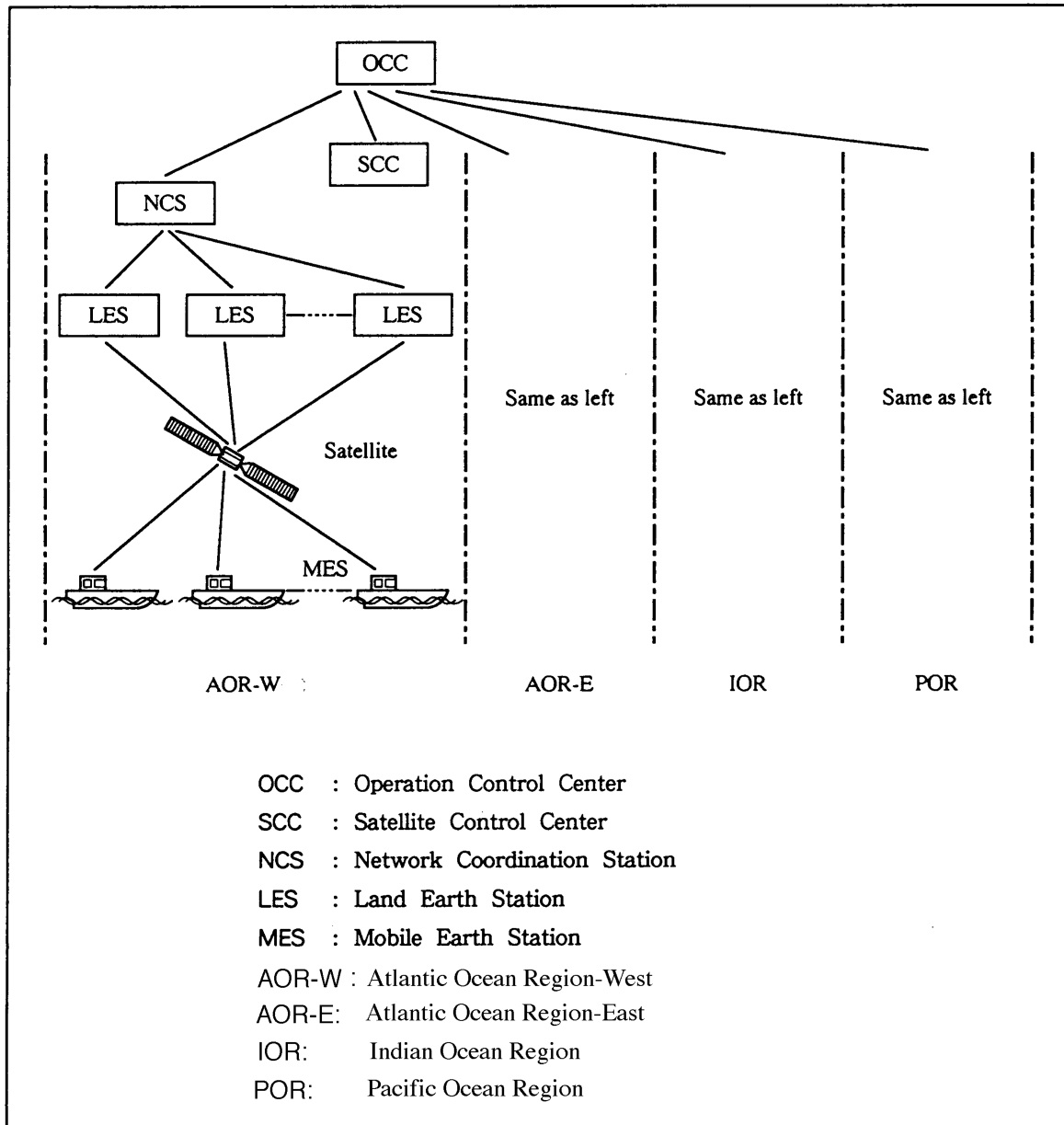

Figure 2 Inmarsat-C satellite communication system

The Inmarsat-C system consists of the Operation Control Center (OCC), Satellite Control Centers (SCC), Network Coordination Stations (NCS), Land Earth Stations (LES) and Mobile Earth Stations (MES). The OCC, located at Inmarsat's London headquarters, coordinates a wide range of activities in the Inmarsat system, including commissioning of mobile earth stations.

The Inmarsat-C system divides the world into four regions and each region is covered by its own satellite.

*Table 1 Inmarsat system satellites*

<b>Region</b>	<b>Satellite</b>	<b>Satellite Position</b>
AOR-West	Inmarsat-2, F4	54.0°W
AOR-East	Inmarsat-2, F2	15.5°W
IOR	Inmarsat-2, F1	64.5°E
POR	Inmarsat-2, F3	178.0°E

In each region there is one NCS and several LESs. The NCS keeps track of all Inmarsat-C transceivers in its region and broadcasts information such as navigational warnings, weather reports and news. The LES provides the link between the MES and the terrestrial telecommunications networks via satellite.

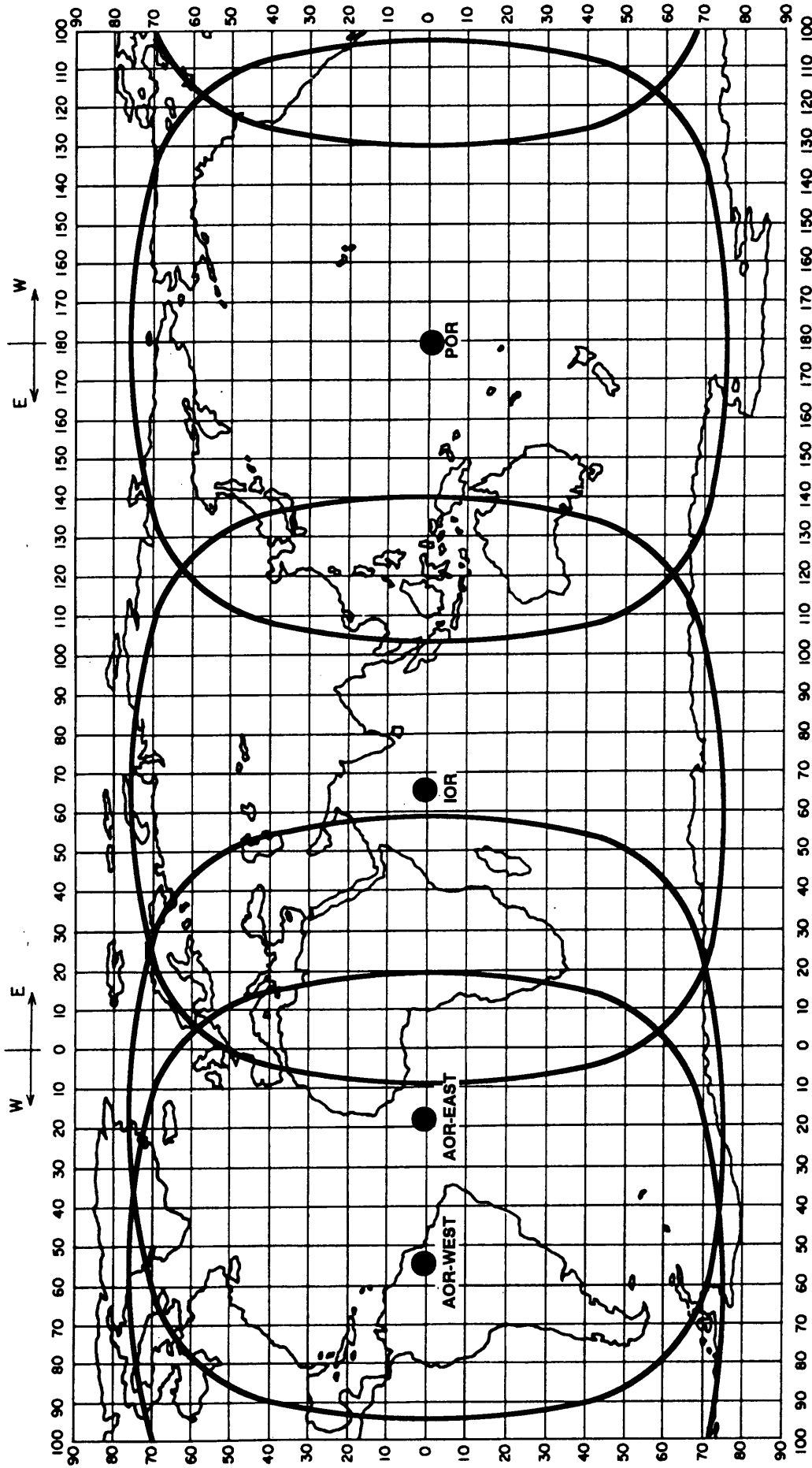

AREA	SATELLITE NAME	POSITION
POR	INMARSAT-2, F3	178° E
IOR	INMARSAT-2, F1	64.5° E
AOR-EAST	INMARSAT-2, F2	15.5° W
AOR-WEST	INMARSAT-2, F4	54.0° W

Figure 3 Coverage area of satellites

# Communications Network

Figure 4 shows the Inmarsat-C communications network.

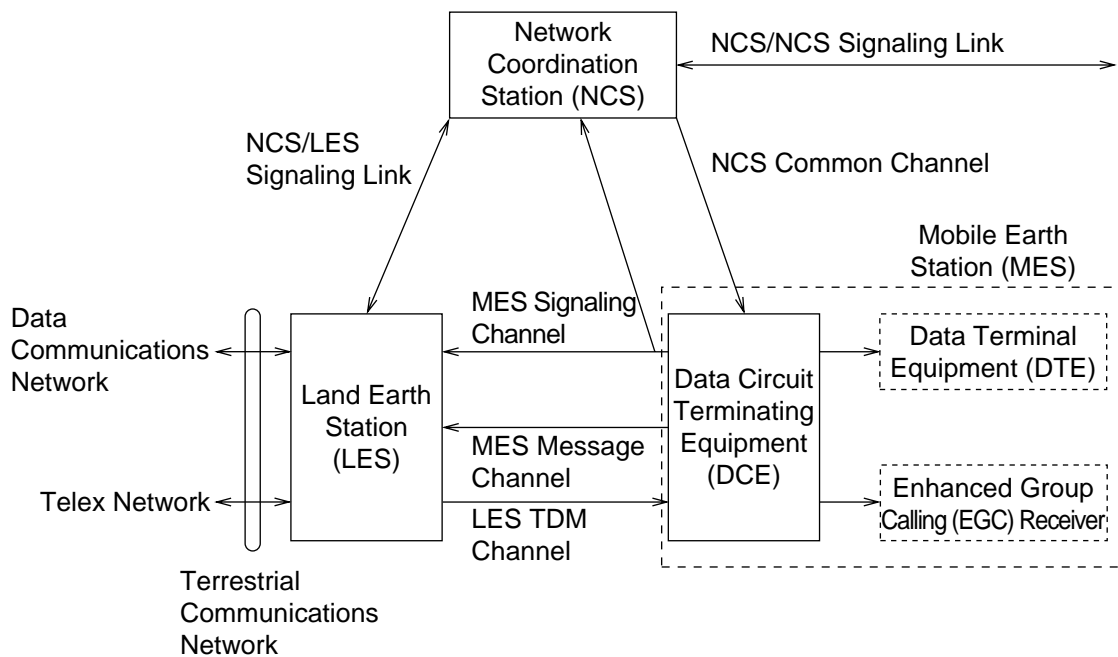

Figure 4 Inmarsat-C communications network

- NCS common channel** The NCS has two major functions:  
 1) Transmitting information on a common channel.  
 2) Transmitting EGC messages to MESs.
- NCS/LES signalling link** This is the link between NCS and all LESs in its region. All EGC messages pass through this link.
- LES TDM channel** This channel carries the circuit control signal for MES and transmits messages from LES to MES.
- MES message channel** This channel carries messages from MES to LES.
- MES signaling channel** This channel transmits requests, distress alerts, data reports, etc. In addition, it carries login and logout from MES to NCS.
- NCS/NCS signaling link** This is the link between NCSs. It exchanges data between MESs operating in different ocean regions.

**MES interface**

The MES consists of the Data Circuit Terminating Equipment (DCE) and the Data Terminal Equipment (DTE). The DCE consists of the antenna unit and the communication unit. And the DTE consists of the terminal unit (or a PC), keyboard and printer.

**Terrestrial network interface**

The major functions of the LESs are:

- 1) Telex store-and-forward conversion
- 2) Handling EGC messages
- 3) Handling distress alerts
- 4) Data Reporting and Polling

**Types of MES**

There are three types of MES: class 1, class 2 and class 3. The FELCOM 12 is a class 2 MES.

**Class 1**

- 1) Transmits messages to LES
- 2) Receives messages from LES

**Class 2**

- 1) The functions of class 1 plus operation as an EGC receiver when not transmitting or receiving.
- 2) EGC-only receiver

**Class 3**

The function of class 1 plus simultaneous operation as a EGC-only receiver.

# Peripheral Equipment

The following equipment can be additionally connected to the FELCOM 12.

## Distress/Urgent Receiving Unit (IC-303)

The IC-303 releases an audible alarm and blinks the lamp when distress message is received. (Refer to page 4-26 for further details.) When an EGC distress or urgent message is received, with an aural alarm and blinking lamp.

## Distress Alert Unit (IC-302)

The IC-302 enables transmission of the distress alert from a remote location; for example, ship's bridge. (Refer to page 6-3 for more details.)

## Distress Message Controller (DMC-5:Option)

The DMC provides for transmission and monitoring of the distress alert. For further details, refer to the operator's manual of the DMC-5.

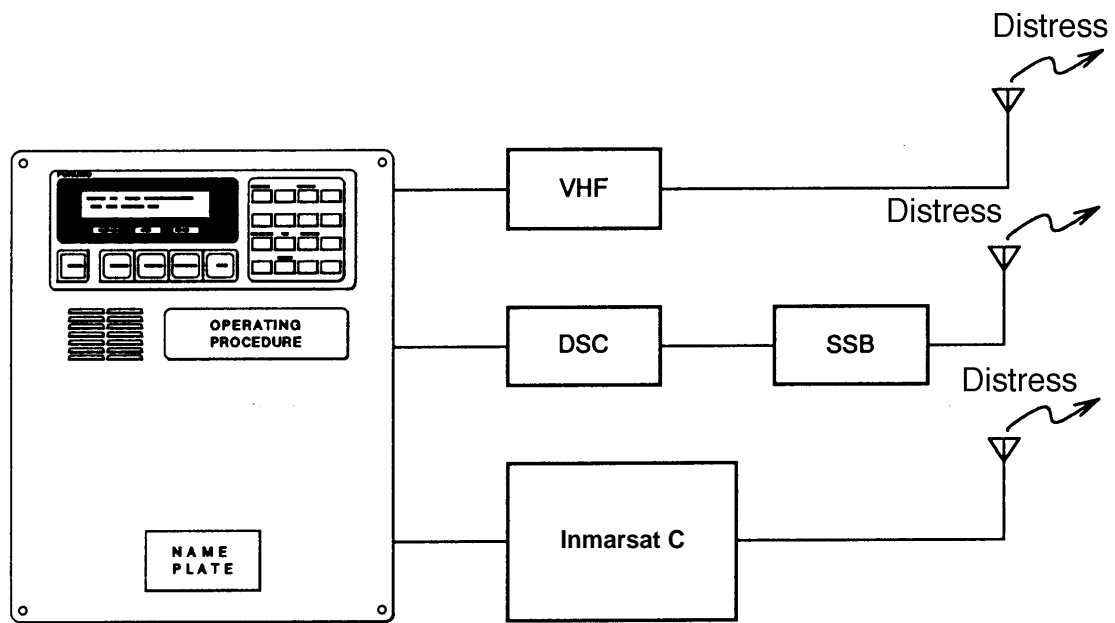

Distress Message Controller DMC-5

Figure 5 Distress Message Controller system

This page is intentionally left blank.



# OPERATIONAL OVERVIEW

This chapter provides an overview of the FELCOM 12 system.

## The Communication Unit

The communication unit is the heart of the FELCOM 12 system, transmitting and receiving messages and alerting you to equipment fault.

On its front panel you should see the POWER switch and POWER lamp. Normally, the power is left on while underway.

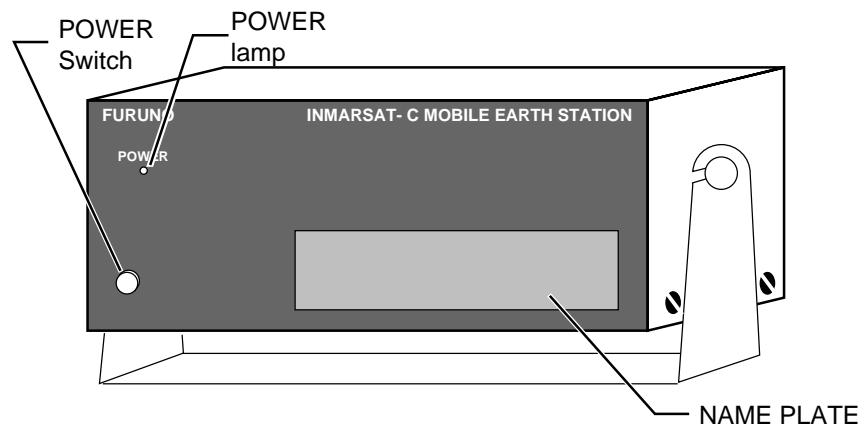

Figure 1-1 Communication unit IC-212

### Self test

When the communication unit is turned on it conducts a series of self-tests to check itself for proper operation.

### When the audible alarm sounds

The audible alarm sounds in the following circumstances:

- 1) EGC distress or urgent message is received. (To silence the alarm, press [ESC] followed by [F10].)
- 2) During the interval between the transmission of the distress alert (by own vessel) and the receiving of the distress acknowledge signal from LES. (The alarm automatically stops when your ship receives the distress acknowledge signal.)
- 3) The system status monitor detects equipment fault. (To silence the alarm, press any key.)

The audible alarm sounds and the terminal unit displays which alarm is sounding.

# The Terminal Unit

The DTE may consist of IB-581 or IBM compatible pc. All operations are carried out from the terminal unit, through an easy-to-understand menu system. For personal computer connection a system disk (supplied) is required to boot up the computer. Operation by a computer is the same as with the terminal unit except when turning on the power.

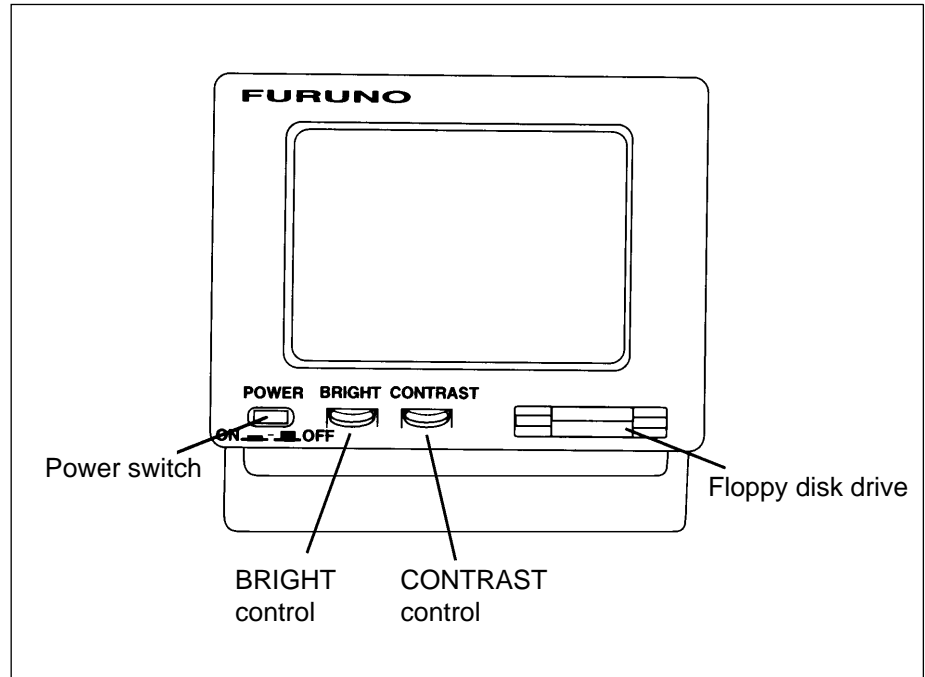

*Figure 1-2 Terminal unit IB-581*

To turn on/off the unit, press the POWER switch.

Controls for adjustment of screen brilliance and contrast are to the right of the POWER switch.

## Floppy disk drive

The terminal unit provides a floppy disk drive for storing transmitted and received messages on floppy disks.

## Floppy disk

The floppy disk used with the system is a standard 3.5" floppy disk. Always leave a floppy disk inserted to save incoming messages.

Terminal unit cannot print file from a floppy disk when there is not enough space remaining on the disk. In this case, replace disk with formatted disk.

## Printer PP-510 (optional supply)

The printer prints transmitted and received messages. The POWER switch is on the right side of the unit. A lamp on the switch lights when the power is on. If the paper is set correctly the ON LINE lamp also lights. When both these lamps are lit the printer is ready to print information received from the terminal unit. For further details, refer to the operator's manual of the PP-510.

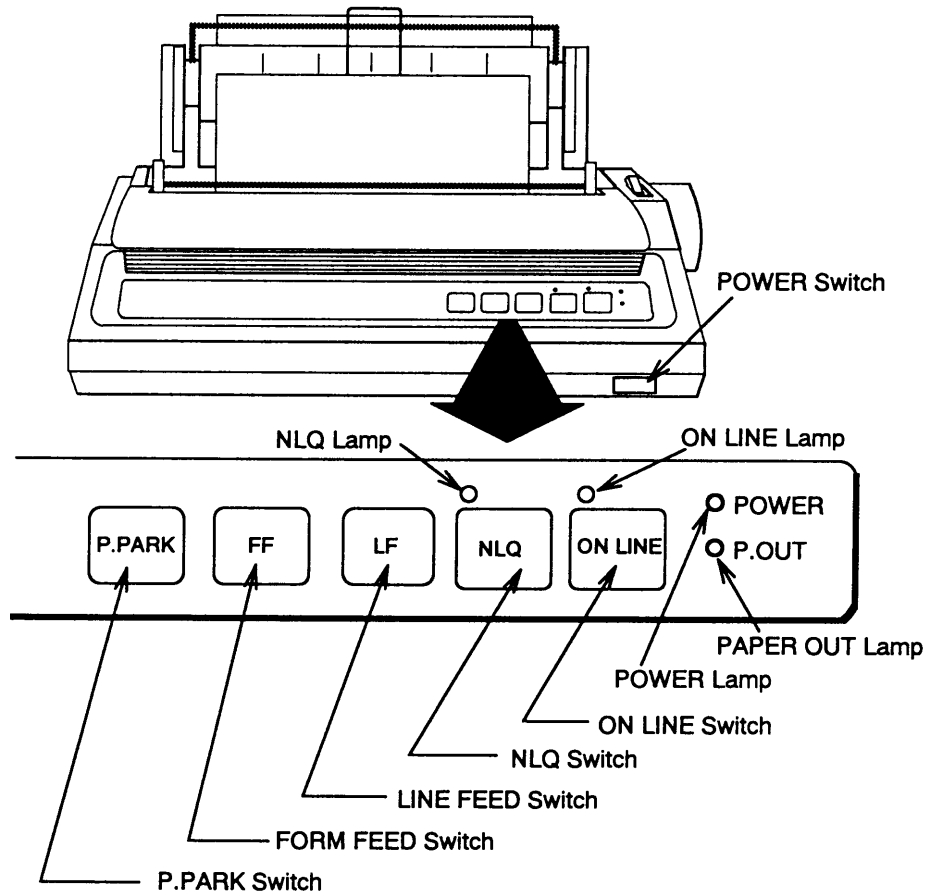

Figure 1-3 Printer PP-510

# Keyboard

The FELCOM 12 is almost 100% keyboard controlled. Operation is simplified by the use of menus which you access by pressing function keys, numbered F1-F10 at the top of the keyboard. Figure 1-4 shows keyboard layout.

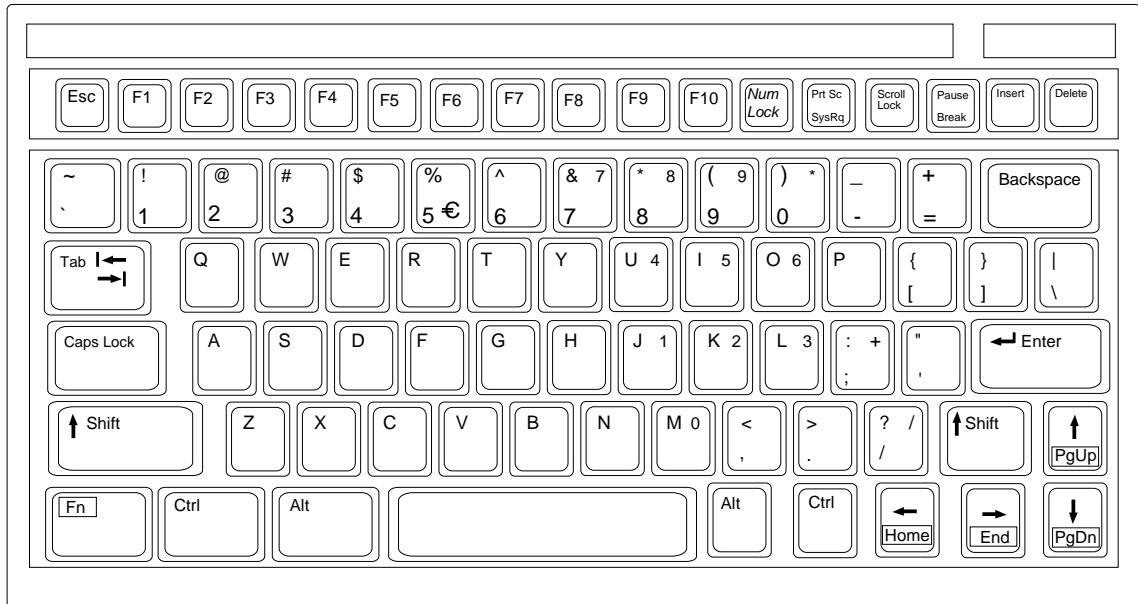

Figure 1-4 Keyboard

## Key description

<b>Esc</b>	Cancels key input and returns to previous display screen.
<b>F1-F10</b>	These are the function keys. They select menus.
<b>Backspace</b>	Deletes the character to the left of the cursor.
<b>Insert</b>	Works the same as PASTE function. See page 3-5.
<b>Delete</b>	Deletes the character on the cursor.
<b>Home</b>	Moves the cursor to the top of a message being edited.
<b>End</b>	Moves the cursor to the bottom of a message being edited.
<b>PgUp</b>	Goes to the previous page of the edit screen.
<b>PgDn</b>	Goes to the next page of the edit screen.
<b>[↑], [↓], [←], [→]</b>	Control the cursor.
<b>Enter</b>	Registers key input.

**Shift** Selects upper or lower case letters. Press and hold down the key to get upper case letters. Note that only upper case letters are used in telex.

**Alt** Executes the shortcut key operation when combined with an alphabet key.

**Space Bar** Inserts a space. In addition, it displays file list, partial view of a file, etc. depending on menu.

**Caps Lock** Turns upper case letter input on or off. CAPS appears on the display when the keyboard is set for upper case letter input.

**Tab** Inserts horizontal tab characters. The number of tab characters the key can insert per line of text can be programmed for two, four or eight tabs.

**Ctrl** Works in combination with alphabet keys as follows:

Ctrl key shortcut keys

Ctrl+[M]	Same as Enter.
Ctrl+[H]	Same as Back Space.
Ctrl+[I]	Same as Tab.
Ctrl+[V]	Same as Overwrite+Insert

**FN** Combined with an arrow Key, it scrolls screen( ↑ , ↓ ),or shifts cursor (←, →).

**Num Lock** Turns numeric input on or off. Note that you cannot enter alphabet when the Num LED is its.

**Note1:** *In telex, lower case, #, &, \*, \$ or % are not used. A full list of characters usable in telex appears on page A-11 in the Appendix.*

**Note2:** € (Euro mark) on  key is not used.

## Shortcut key operation

The FELCOM 12 provides the keyboard shortcuts shown below for commonly used functions.

*Table 1-2 Shortcut keys*

Short Cut key	Operation
ALT+N	Same as <b>NEW</b> in File menu
ALT+O	Same as <b>OPEN</b> in File menu
ALT+Q	Same as <b>CLOSE</b> in File menu
ALT+D	Same as <b>DELETE</b> in File menu
ALT+S	Same as <b>SAVE</b> in File menu
ALT+P	Same as <b>PRINT</b> in File menu
ALT+X	Same as UNDO
DELETE	Same as <b>CUT</b> in Edit menu
ALT+C	Same as <b>COPY</b> in Edit menu
INSERT	Same as <b>PASTE</b> in Edit menu
Fn+← (Home)	Same as <b>Top of Text</b> in Edit/Go to line menu
Fn+→ (End)	Same as <b>End of Text</b> in Edit/Go to line menu
ALT+V	Same as <b>CHANGE WINDOW</b> in Edit menu

## Function Menus

The function menus, which you access by pressing the function keys (F1-F10) at the top of the keyboard, control most operations of this unit.

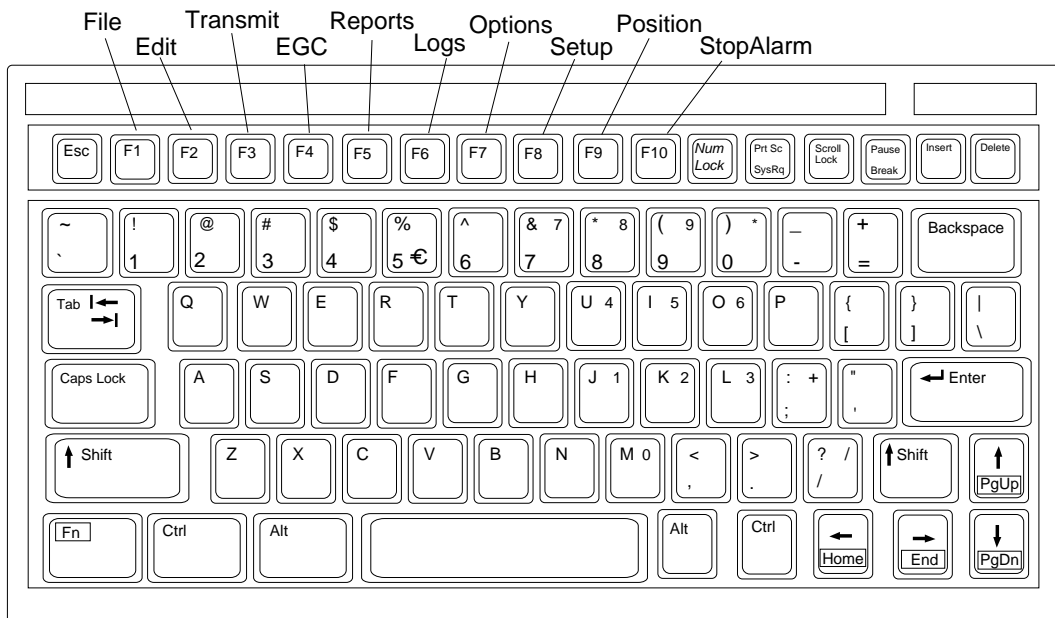

## Selecting menu, menu options

Press appropriate function key to select a menu. For example, press [F1] to select the File menu.

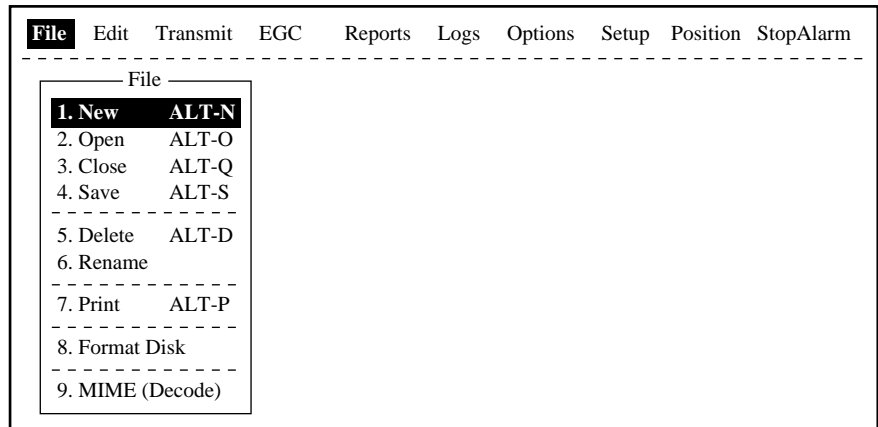

*Figure 1-6 File menu*

You may select menu options with the arrow keys (pressing [Enter] after making selection) or appropriate numeric key. As the cursor moves down through a menu, when using the arrow keys, each menu option, initially shown as white on black, reverses to black on white. This highlighting indicates the item is available for selection. In Figure 1-6, for example, “New” is available for selection.

## Function menu description

*Table 1-3 Function menu description*

Menu	Description
File	Processes files.
Edit	Provides text editing facilities.
Transmit	Transmits messages.
EGC	Sets up EGC message facilities.
Reports	Sets up data reporting function.
Logs	Displays send and receive message logs.
Options	Login, logout, testing facilities.
Setup	Sets up the system.
Position	Enters your ship's position.
Stop Alarm	Silences buzzer.

## Sample menu operation

For example, you want to display a transmitted message. All operations begin from the standby display.

File	Edit	Transmit	EGC	Reports	Logs	Options	Setup	Position	StopAlarm
Date		97-08-04				BBER			000
Time		01:32 (UTC)				C/N			OK ( 36dB)
						Send level			OK ( 0)
Position		LAT				RxIF AGC Level			OK (135)
		LON				REF Offset Freq			OK ( 0Hz)
Waypoint		LAT				Synthe 1st-1 Local			OK
		LON				1st-2 Local			OK
Course		DEG				RX2nd Local			OK
Speed		KTS							
Current NCS		344 (IOR)	LOGOUT			Antenna Power Supply			OK
Current Channel		NCS CC							
Current TDM		NCS CC				Water Temperature			DEG
MES Status		Idle				Water Current			
GPS Status		****				Direction			DEG
						Speed			KTS
DCE Memory		32818 Bytes free				Depth			
-----									
Current State: IDLE				SYNC ( NCS )		97-08-04 01:32 (UTC)			
DCE Ver **				NCS: IOR		LOGOUT			

Figure 1-7 Standby display

Press [F6] to display the Logs menu.

File	Edit	Transmit	EGC	Reports	Logs	Options	Setup	Position	StopAlarm
-----									
Log									
1. Send Message Log									
2. Receive Message Log									
3. EGC Log									
4. Log									

Figure 1-8 Logs menu

Press [1] to display the send message log.

File	Edit	Transmit	EGC	Reports	Logs	Options	Setup	Position	StopAlarm
-----									
Log									
1. Send Message Log									
2. Receive Message Log									
Send Message Log									
No.	Message File	Station	LES	Priority	Send Status	Delivery			

Figure 1-9 Send message log

Select the message you want to display by pressing [ ↑ ] or [ ↓ ] followed by [Enter].



# Display Indications

The display is divided in three sections:

- 1) The menu area
- 2) The working area
- 3) The operating status area

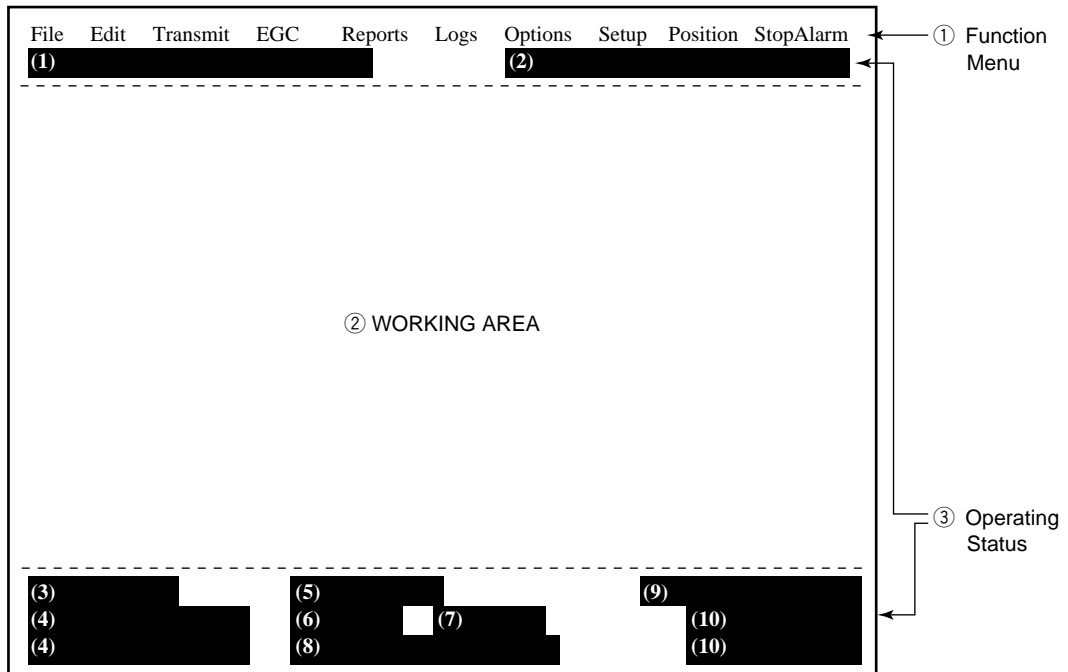

Figure 1-10 Location of display indications

Below are indications and their meanings.

## (1) Distress alert information

- No display (no distress alert)
- Distress Alert Activated
- Distress Alert Test Activated
- Distress Alert Acknowledge Received
- Distress Message Call Activated
- Distress Message Call Acknowledged

## (2) Communication network mode

- |                                       |  |
|---------------------------------------|--|
| No display                            | Normal operation   |
| Restoration Mode (blinking)           | Problem at NCS.  |
| Restoration Mode (reverse indication) | Previously designated LES is transmitting the NCS common channel signal. |

### **(3) Communication unit status**

Idle	Idle (awaiting receiving, awaiting transmitting)
Idle (pending)	Awaiting reply from LES
Sending	During message transmission
Receiving	During receiving
Login	Logging in with NCS
Logout	Logging out with NCS
Distress Alert	When own vessel is transmitting the distress alert
Data Report	During transmission of data report
Testing	PV testing
Test Setup	Requesting PV testing
Scanning	NCS scanning
EGC RECEIVER (reverse indication)	EGC-only receiver operation
Delivery Status Req.	When transmitting delivery status request
Forced Clearing	When stopping receiving, transmitting, or scanning

### **(4) Communication unit remarks and DCE version number**

This area provides remarks about communication unit status.

### **(5) Frame synchronization**

Blank	When changing channel, or during transmission
SYNC (NCS)	Synchronizing with NCS
SYNC (LES)	Synchronizing with LES
UNSYNC	Out of synchronization
Retuning	Synchronizing with NCS or LES

### **(6) Ocean region receiving**

No display	Out of synch with satellite
AOR-W	Atlantic Ocean Region-West
AOR-E	Atlantic Ocean Region-East
IOR	Indian Ocean Region
POR	Pacific Ocean Region

## (7) Logging status

LOGOUT	Logged out with ocean region
LOGIN	Logged in with ocean region
LOGIN (blinking)	Logging in with ocean region

## (8) Other information

No display	No receive message in memory, or printer is operating.
REC. MESSAGE EXISTS (blinking)	Displayed when a routine message has not been printed, or a confidential message is received.
DATA REPORT (Reverse indication)	When data reporting is activated.

## (9) Date and time display

The date (set at system setting) and time (set by satellite) appear. Time is updated every minute (with navigator connection).

## (10) Ship's position

Ship's position (automatic or manual input) appears here.

# Error Messages and Alerts

The terminal unit displays error messages and alerts to call your attention to misoperation, failed operation and system error. A list of error messages and alerts appears on pages A-12 through A-14 in the Appendix. To erase an error or an alert, press [Esc].

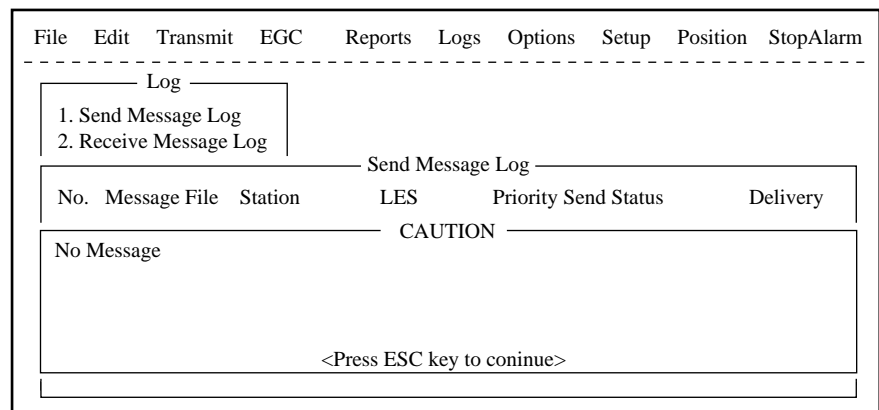

Figure 1-11 Location of error messages and alerts

# Silencing the Audible Alarm

Some error messages and alerts are accompanied by the audible alarm. This alarm can be silenced, in most instances, by pressing any key. If the alarm cannot be silenced in that manner, go to the Setup menu to silence it. Note that the distress alert alarm transmitted by own ship cannot be silenced by either method; it automatically stops when you receive the distress acknowledge signal from LES.

## Silencing the alarm by the Setup menu

1. Press [F8] to display the Setup menu.

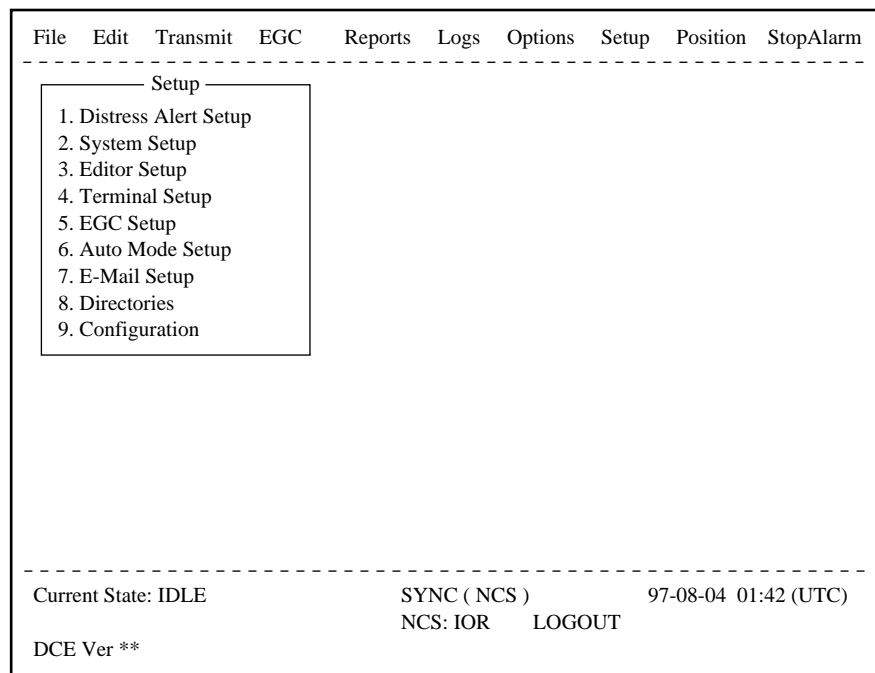

Figure 1-12 Setup menu

2. Press [6] to display the Auto Mode Setup menu.
3. Press [ ↓ ] key to go to the Receive Alarm line.
4. Press [Enter] to open the selection window.

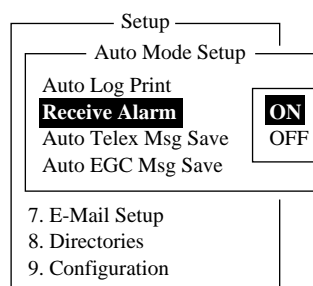

Figure 1-13 Auto mode setup menu

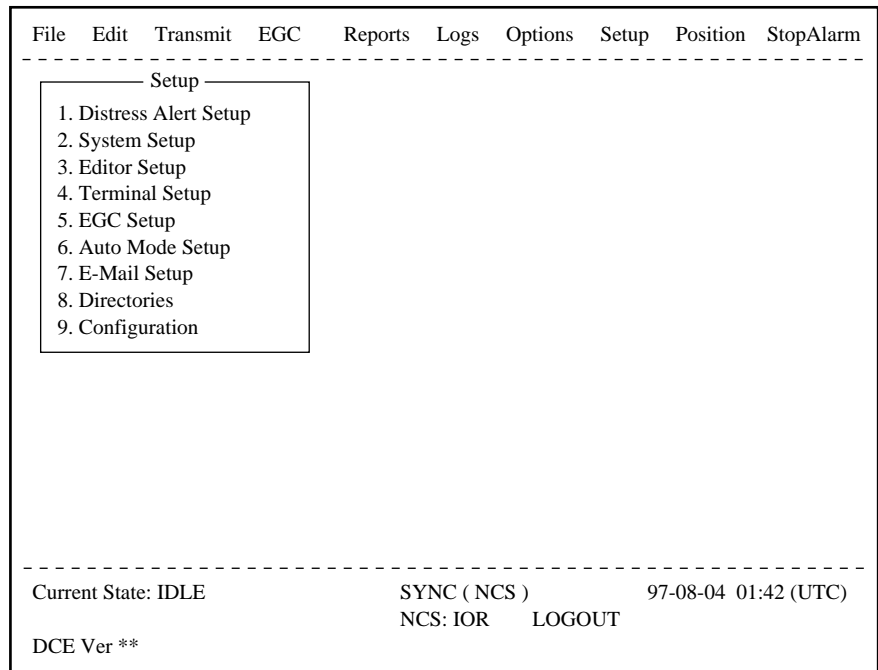

Figure 1-12 Setup menu

2. Press [6] to display the Auto Mode Setup menu.
3. Press [ ↓ ] key to go to the Receive Alarm line.
4. Press [Enter] to open the selection window.

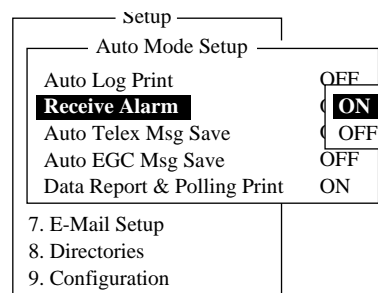

Figure 1-13 Auto mode setup menu

5. Press [ ↓ ] to select OFF.

**Note:** To silence the audible alarm given to an EGC distress or urgent message from Distress Alert Unit (IC-302), follow the above procedure. DO NOT press the DISTRESS button on the IC-302 to silence the alarm; you will transmit own ship's distress alert.

6. Press [Enter] to close the selection window.
7. Press [Esc] twice.

## Contents of program disk

READ.ME:	Instructions for installation of software
IBINST.BAT:	English software for IB-581
IBRINST.BAT:	Russian software for IB-581
PCINST.BAT:	English software for PC
PCRINST.BAT:	Russian software for PC
INSTALL.BAT:	Program start up
FELCOM12.EXE:	Terminal software
ENGLISH.DAT:	English text definition file
RUSSIAN.DAT:	Russian text definition file
ENH_FONT.EXE:	Russian driver
DTE.DAT:	Terminal software definition file (for PC)
DTE.B:	Terminal software definition file (for IB-581)
LES.DAT:	LES list
FORMAT.COM:	Format disk

# SYSTEM INITIALIZATION

This chapter provides the information necessary for initializing the FELCOM 12. Once the FELCOM 12 is initialized you need do no more than press a few keys to get fully automatic transmission and reception.

Inmarsat assigns each MES an Inmarsat Mobile Number (IMN). The IMN has already been entered into the FELCOM 12.

## System Settings

### Two sets of DTEs installed

The communication unit provides two sets of connectors (DTE1, main; DTE2, 2nd) for connection of two DTEs. It is preset at the factory for connection with one DTE (main DTE). Main DTE is available to set the menu.

1. Press [F8] to select the Setup menu.

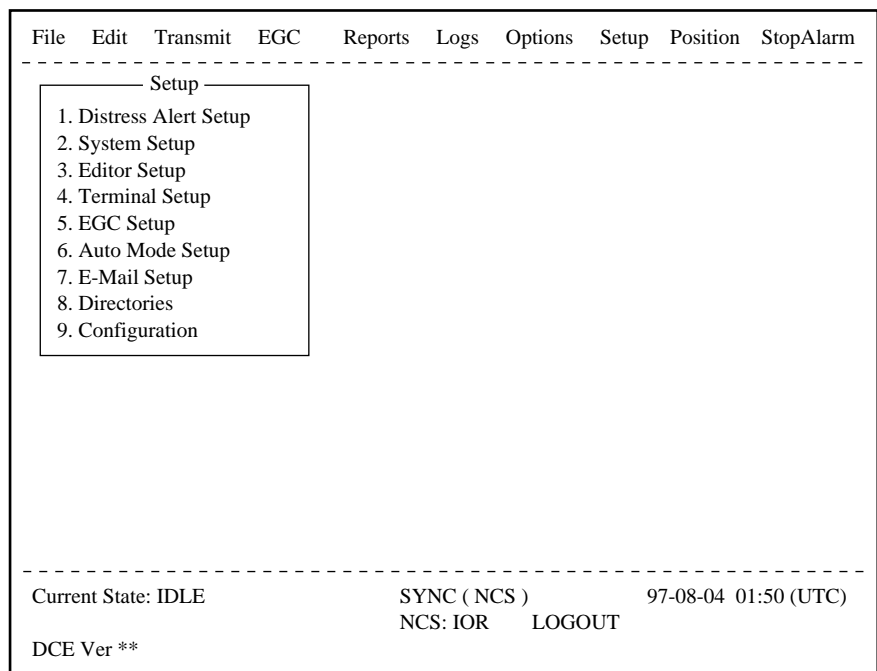

*Figure 2-1 Setup menu*

Menu Items which cannot be set on 2nd DTE (Sub DTE ) are shown in gray.

## System setup

The System Setup menu provides for input of date, time, operating mode, and port function.

1. Press [F8] to select the Setup menu.

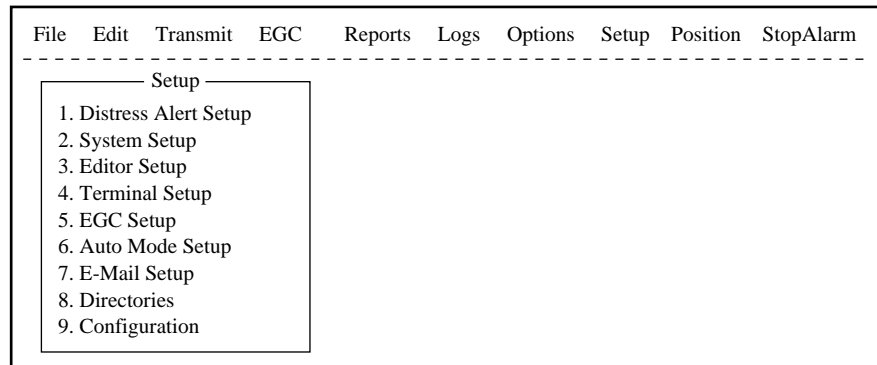

Figure 2-4 Setup menu

2. Press [2] to display the System Setup screen.

**Note:** *If the communication unit is off or its interconnection cable has loosened or is damaged, “No response from communication unit.” appears.*

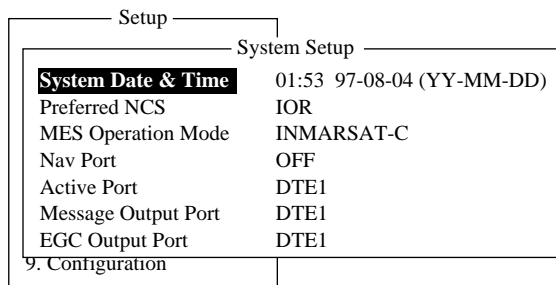

Figure 2-5 System setup menu

3. Press [Enter] to open the date window.

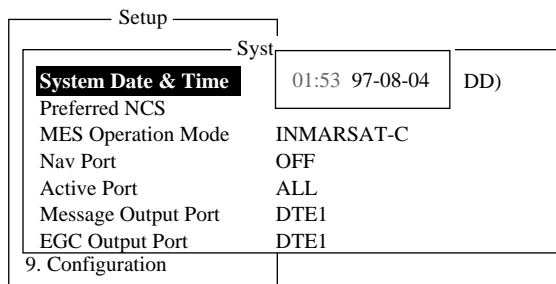

Figure 2-6 System setup menu, system date & time

4. Enter the date.
5. Press [Enter] to close the window.
6. Press [↓] to advance the cursor to the Preferred NCS line.

**Note:** *Date cannot be entered in the FFA version.*



7. Press [Enter] to open the selection window.

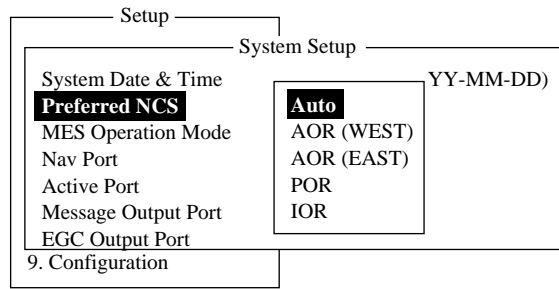

Figure 2-7 System setup menu, preferred NCS

8. Select appropriate NCS (Auto, AOR-West, AOR-East, POR or IOR) by arrow keys. The FELCOM 12 will search for that NCS signal each time it is turned on. The Auto setting searches all NCS signals to find the most suitable NCS; thus, scanning can take quite some time. (For reference, the coverage range of each satellite is shown in the figure on page 8.)

If you want to change the NCS channel temporarily, refer to “Selecting NCS channel” on page 7-4.

9. Press [Enter] to close the selection window.

10. Press [ ↓ ] to advance the cursor to the MES Operation Mode line.

11. Press [Enter] to open the selection window.

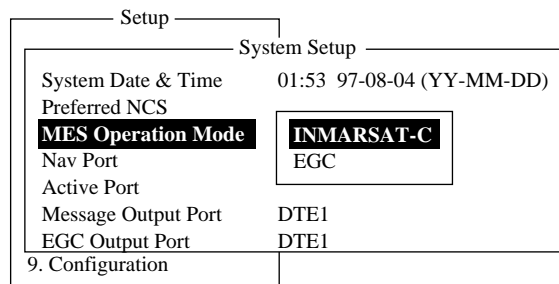

Figure 2-8 System setup menu, MES operation mode

12. Select operating mode, either Inmarsat C or EGC. The Inmarsat C setting provides telex communications and operates as an EGC receiver when not transmitting or receiving. The EGC setting enables EGC-only receiver operation. In this case EGC RECEIVER appears in reverse indication at the bottom of the screen.

13. Press [Enter] to close the selection window.

14. Press [ ↓ ] to advance the cursor to the Nav Port line.

**Note:** The MES Operation Mode in the FFA version cannot be set to other than “Inmarsat C.”

15. Press [Enter] to open the selection window.

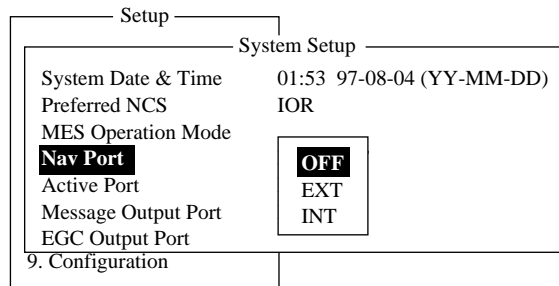

Figure 2-9 System setup menu, nav port

16. Select the navigation device which is interfaced to the FELCOM 12.

**OFF:** No connection

**EXT:** Select this setting when external navigation device is connected. The FELCOM 12 automatically selects ship's position information in the order of GPS, LC, and DECCA.

**INT:** Internal GPS board provides position data.

**Note:** The Nav Port setting in the FFA version cannot be set to other "INT."

**Note:** If there is no navigation equipment connection (Nav Port setting is "OFF"), you should input dead reckoning position in the Position menu. Refer to page 2-26.

17. Press [Enter] to close the selection window.

18. Press [ ↓ ] to advance the cursor to the Active Port line.

19. Press [Enter] to open the selection window.

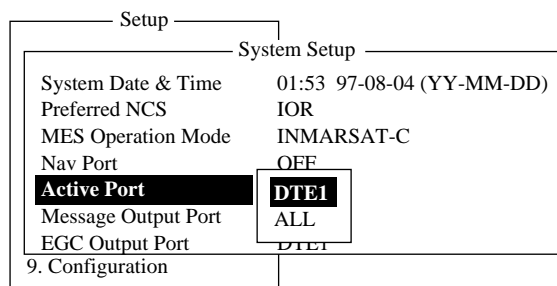

Figure 2-10 System setup menu, active port

20. Select active port (DTE); "DTE1" or "ALL".

**DTE1:** Only DTE1 is active.

**ALL:** DTE1, DTE2 and PC/DATA are active.

21. Press [Enter] to close the selection window.

22. Press [ ↓ ] to send the cursor to the Message Output Port line.

23. Press [Enter] to open the selection window.

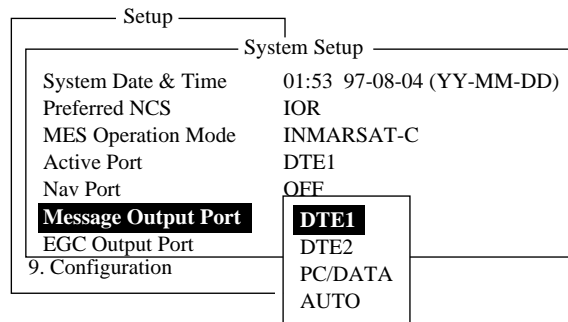

Figure 2-11 System setup menu, message output port

24. Select the DTE where you want to store receive messages.

- DTE1:** All receive messages are routed to the main DTE (connected to DTE1 on the communication unit) regardless of sub address.
- DTE2:** All receive messages are routed to the 2nd DTE (connected to DTE2 on the communication unit) regardless of sub address.
- PC/DATA:** All receive messages are routed to the PC/DATA (connected to PC/DATA on the communication unit) regardless of sub address (not used).
- AUTO:** Select to route messages with sub address 000 to the main DTE, and messages with the sub address of the 2nd DTE to the 2nd DTE. All other messages are routed to the main DTE.

**Note:** Do not select DTE2 or Auto when there is no DTE connected to the DTE2 port; messages cannot be read from the communications unit.

25. Press [Enter] to close the selection window.

26. Press [ ↓ ] to advance the cursor to the EGC Output Port line.

27. Press [Enter] to open the selection window.

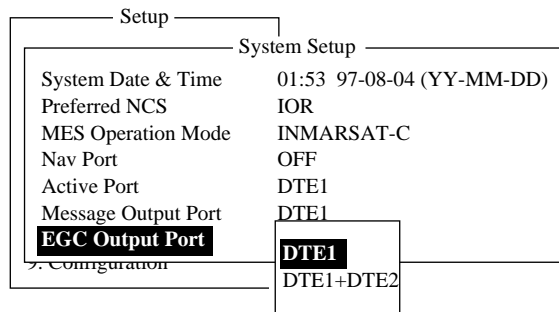

Figure 2-12 System setup menu, EGC output port

28. Select the DTE where you want to store receive EGC messages; DTE1, DTE2 or PC/DATA.

29. Press [Enter] to close the selection window.

30. Press [Esc] to open the update window.

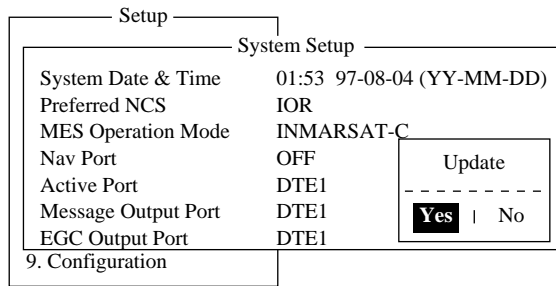

Figure 2-13 System setup menu, update

31. Press [Enter] to select “Yes”.

32. Press [Esc] to register all system setup settings and return to the standby display.

## Terminal Setup

Terminal Setup menu provide for date display format,screen saver and display mode.

1. Press [F8] to select the Setup menu.
2. Press [4] to display the Terminal Setup screen.

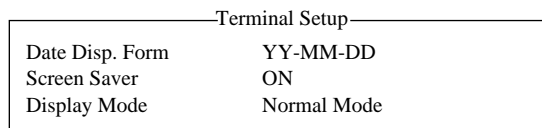

Figure 2-14 Terminal Set up menu.

3. Press [Enter] to open the selection window.
4. Select date display format “YY-MM-DD(year-month-day)”, “MMM-DD-YY(month-day-year)” or “DD-MMM-YY(day - month -year)”.
5. Press [Enter] to close the selection window.
6. Press [ ↓ ] to advance the cursor to the Screen Saver line.
7. Press [Enter] to open the selection window.
8. Select “ON” or “OFF”.
9. Press [Enter] to close the selection window.
10. Press [ ↓ ] to advance the cursor to the Display Mode line.
11. Press [Enter] to open the selection window.

12. Select “Normal Mode” or “Reverse Mode”.  
Normal Mode displays black characters on white background.  
Reverse Mode displays white characters on black background.
13. Press [Enter] to close the selection window.
14. Press [Esc] to return to the standby display.

## Login and Logout

Each time the DTE and communication unit are turned on register your vessel with the Inmarsat C system, to enable communications between your vessel and LES. This is called login. The first time you login you must do it manually; thereafter the NCS does it for you automatically, even when you move to another ocean region.

Note that the distress alert can be transmitted and EGC messages received regardless of whether you are logged in or not.

**If you will not be using the FELCOM 12 for a prolonged period you should logout from the Inmarsat C system, before turning off the power to the communication unit.** The Inmarsat C system will then register you as inactive, notifying anyone trying to call you that you are currently unavailable. If you do not log out before turning off the power, the LES may attempt to send a message to you. **It may charge your correspondent, even if you never receive the message.**

**Note:** *The communication unit should be idle (“Current State: IDLE” appears at the bottom of the screen) to login and logout.*

**Note:** *When the FFA version is active, vessel is automatically logged in when the power is turned on.*

## Login

1. Confirm that “SYNC (NCS)” appears at the bottom of the screen.
2. Press [F7] to display the Options menu.

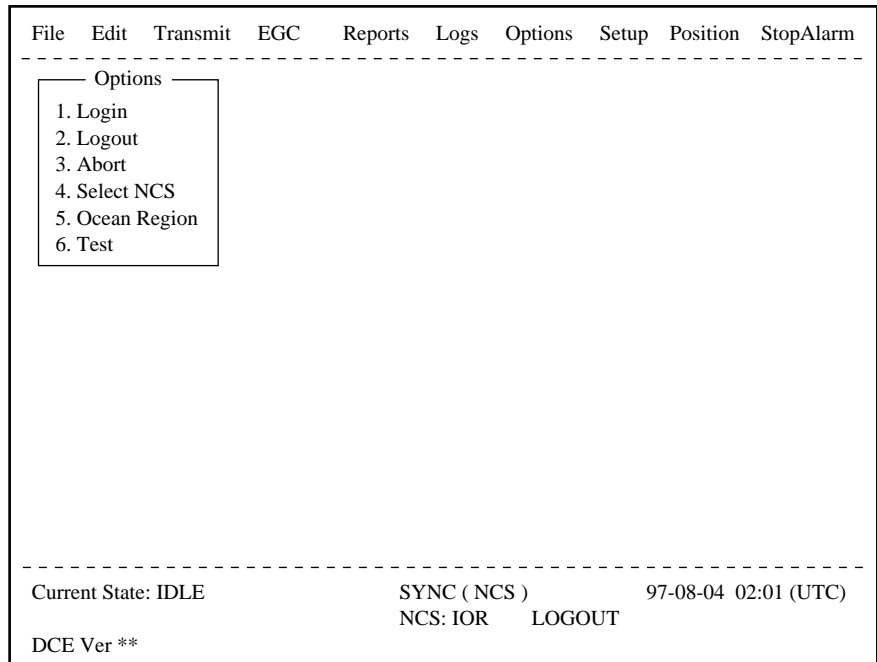

Figure 2-15 Options menu

3. Press [1] to display the Login screen.

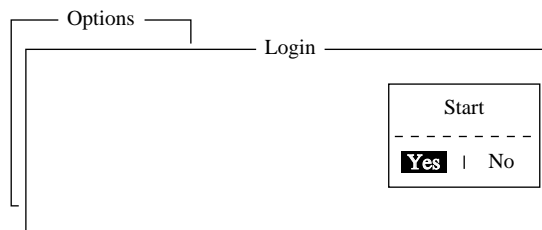
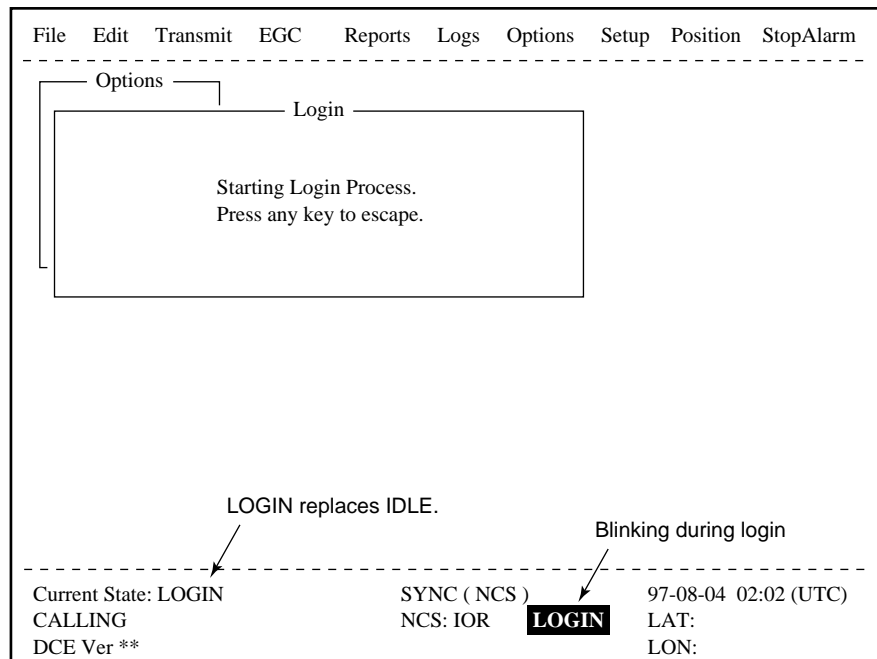

Figure 2-16 Login screen

**Note:** The communication unit must be idle to login. When it is not idle, “Communication Unit is not IDLE now. Cannot start login.” appears. Press any key to return to the standby display. Wait until the communication unit becomes idle.

4. Press [Enter] to start login.

5. LOGIN begins and the screen should now look something like Figure 2-17. The indication LOGIN appears in blinking reverse video.



*Figure 2-17 Appearance of display screen during login*

6. When login is completed, “Successful login” appears. The communication unit goes into Idle state, LOGIN stops blinking and the ocean region you logged in with appears on the screen.
7. Press any key to return to the standby display.

## Logout

1. Press [F7] to display the Options menu.
2. Press [2] to display the logout screen.

**Note:** *The communication unit must be idle to logout. When it is not idle, “Communication Unit is not IDLE now. Cannot start logout.” appears. Press any key to return to the standby display. Wait until the communication unit becomes idle.*

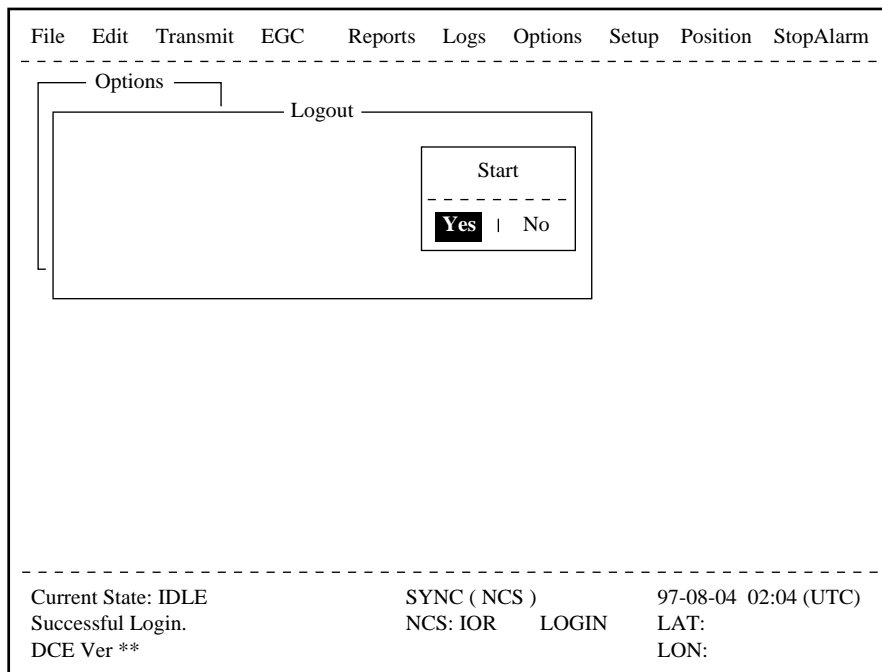

Figure 2-18 Options menu, logout screen

3. Press [Enter] to start logout. Logout begins and the screen now looks something like Figure 2-19.

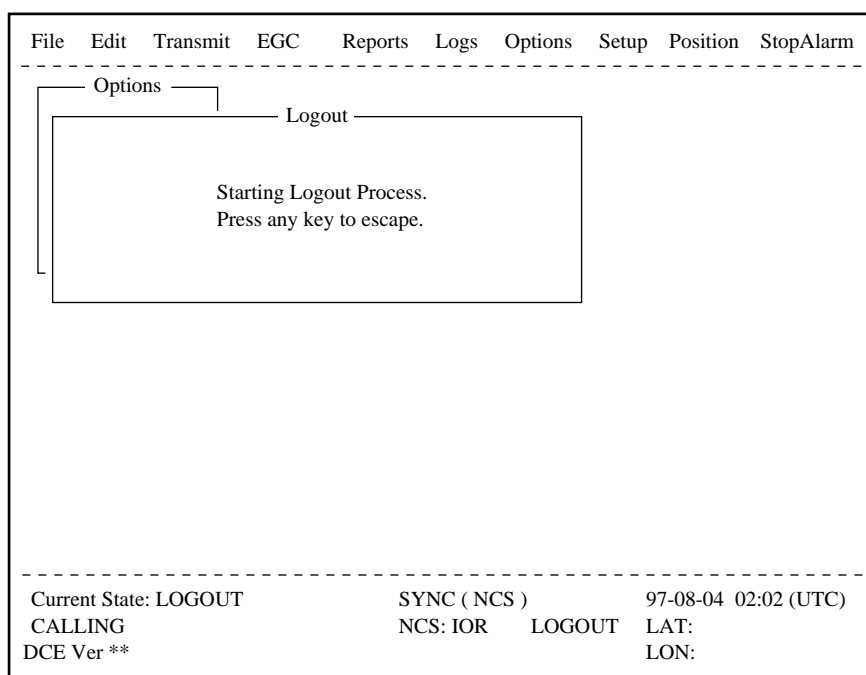

Figure 2-19 Appearance of display screen during logout

4. When logout is completed, “Successful logout” appears. The Current State returns to IDLE.
5. Now you can turn off the power of the FELCOM 12.

**Note:** In the FFA version, the display shows the message “INF: Logout request accepted. please wait.”



# EGC Settings

## What is the EGC (Enhanced Group Call) service?

The EGC service enables EGC information providers to send SafetyNET™ or FleetNET™ messages via a LES to select groups of ships, or to all ships within a defined geographical area.

To send an EGC message, the information provider prepares the message, and then accesses the Country of international telex network to send the message to the LES. The LES processes and forwards it to the NCS for the ocean region designated by the provider. Then, NCS broadcasts the message throughout the ocean region.

Although all MESSs can receive the EGC message, the message is accepted only by those receivers that have been pre-programmed for the area or group conditions contained in the message. All other EGC receivers reject the message.

Two EGC services are available:

### 1) SafetyNET™

This provides a means for information providers to distribute Maritime Safety Information (MSI) from shore-to-ship. Authorized information providers include:

- a. Hydrographic Offices, for navigational warnings
- b. National Weather Services, for meteorological warnings and forecasts
- c. Rescue Co-ordination Center, for shore-to-ship distress alerts and other urgent information
- d. International Ice Patrol, for North Atlantic ice hazards

### 2) FleetNET™

This service allows authorized information providers such as commercial subscription services, shipping companies and governments, which have registered with a LES that supports FleetNET™, to broadcast messages to selected group of MESSs. Typical applications of FleetNET™ are:

- a. Fleet or company broadcasts
- b. News broadcasts
- c. Commercial weather services
- d. Market quotations
- e. Government broadcasts to all vessels on a country's registration

## EGC setup

The FELCOM 12 receives EGC messages directed to its present position and Navarea without further programming. The EGC Setup screen lets you select additional areas for which you wish to receive messages and also the Navtex station and type of message for Coastal Warning (NAVTEX Re-broadcast).

1. Press [F8] to display the Setup menu.

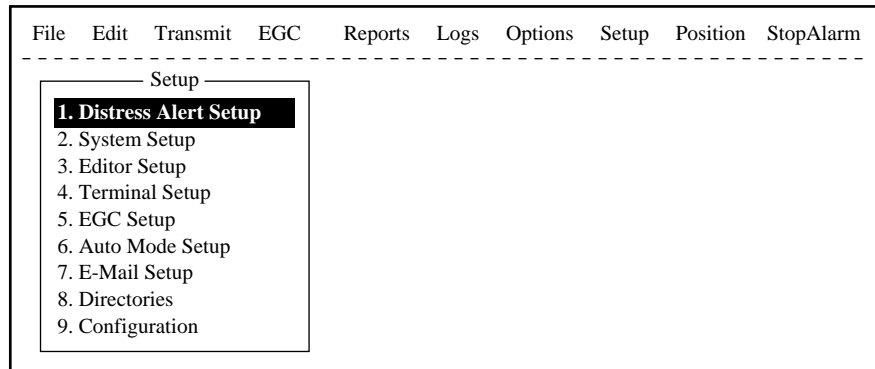

Figure 2-20 Setup menu

2. Press [5] to display the EGC Setup screen.

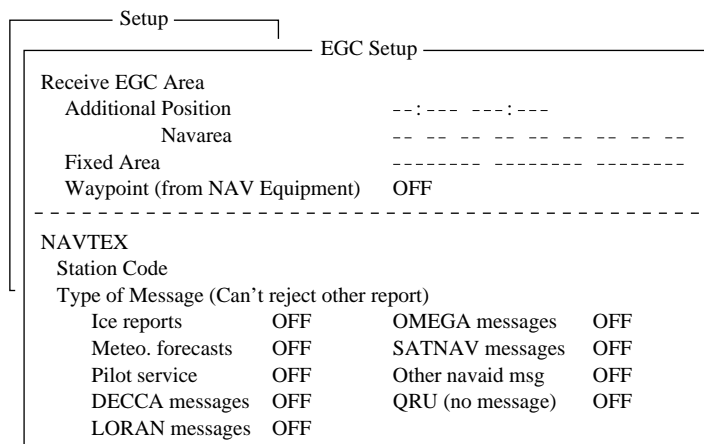

Figure 2-21 EGC setup screen

The cursor is on the Additional Position line, where you can enter L/L position of an ocean region you want to receive broadcasts for.

3. Press [Enter] to open the additional position window.
4. Enter positions as follows.
  - a) Enter latitude.
  - b) Enter [N] or [S].
  - c) Enter longitude.
  - d) Enter [E] or [W].

5. Press [Enter] to close the position window.
6. Press [ ↓ ] to send the cursor to the Navarea line.
7. Press [Enter] to open the Navarea window.

Setup		EGC Setup	
Receive EGC Area			
Additional Position		Navarea	
		-----	
Fixed Area			
Waypoint (from NAV Equipment)		OFF	
-----			
NAVTEX			
Station Code			
Type of Message (Can't reject other report)			
Ice reports	OFF	OMEGA messages	OFF
Meteo. forecasts	OFF	SATNAV messages	OFF
Pilot service	OFF	Other navaid msg	OFF
DECCA messages	OFF	QRU (no message)	OFF
LORAN messages	OFF		

*Figure 2-22 EGC setup screen, Navarea window*

8. Enter additional Navarea(s) (up to nine) for which you want to receive broadcasts. Figure 2-23 shows the Navareas of the world. Referring to the figure below for numeral and alphabet, enter additional Navareas (up to nine) for which you want to receive broadcasts.

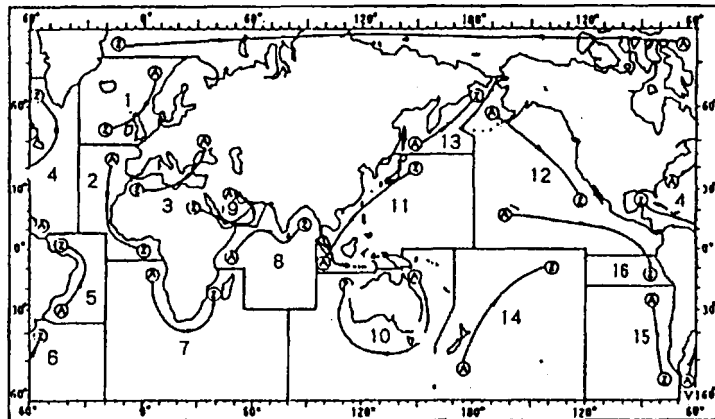

*Figure 2-23 Navareas*

9. Press [Enter] to close the Navarea window.
10. Press [ ↓ ] to send the cursor to Fixed Area.
11. This line is where you enter fixed areas (max. 3) for chart correction service. However, this service is not yet available; enter no data.
12. Press [ ↓ ] to send the cursor to the Waypoint line.

13. Press [Enter] to open the Waypoint window.

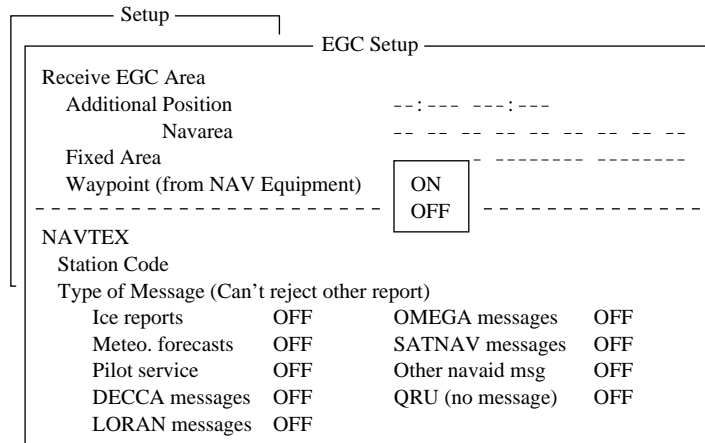

Figure 2-24 EGC setup screen, waypoint

14. Select ON to receive broadcasts for the area of a destination waypoint selected on the navigation device.

15. Press [Enter] to close the Waypoint window.

16. Press [↓] to advance the cursor to the Station Code line.

17. Press [Enter] to open the Station Code window.

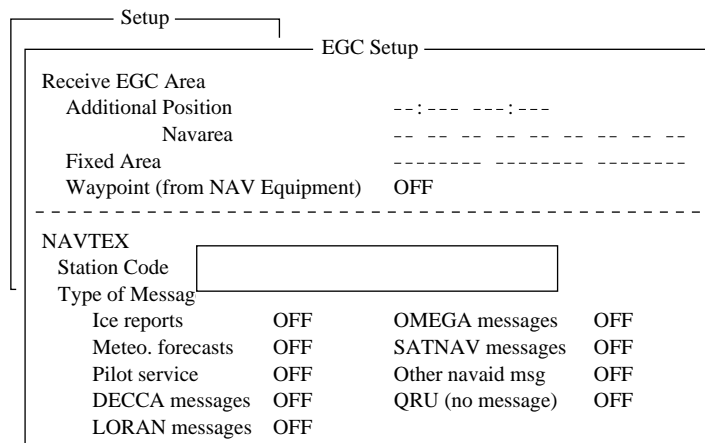

Figure 2-25 EGC setup, station code

18. Enter the navtex station code (A-Z) of the navarea. For details about navtex stations, consult the operator's manual of the navtex receiver.

19. Press [Enter] to close the Station Code window.

20. Using the up/down arrow keys enable/disable reception of NAVTEX broadcasts and press [Enter].

Note that navtex message types “Coastal navigational information”, “Meteorological warning” and “Search and rescue alert” (they do not appear on the display) cannot be deleted since they are considered essential to navigation.

21. Press [Esc] to open the update window.

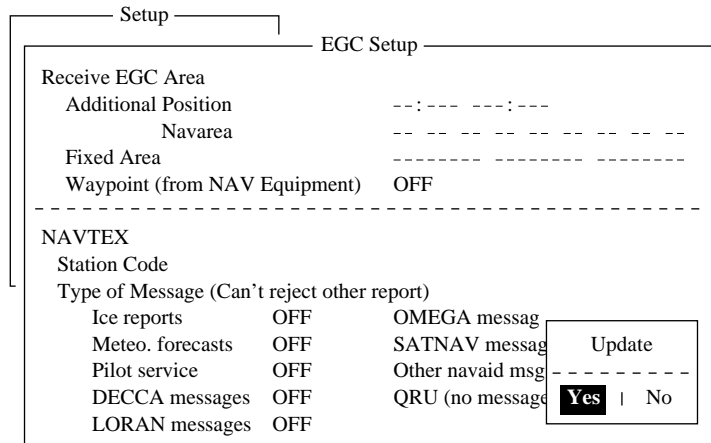

Figure 2-26 EGC setup screen, update window

22. Press [Enter] to select “Yes” and register all EGC settings.

23. Press [Esc] to return to the standby display.

## Programming EGC channels

The EGC Channel List in the Setup menu stores EGC channels.

There are currently four EGC channels, one for each satellite. These four channels are pre-programmed into the unit and marked in the EGC Channel List with asterisks. When more EGC channels become available you can add them to the list.

1. Press [F8] to display the Setup menu.
2. Press [9] to display the Configuration menu.
3. Press [3] to display the EGC Channel List.

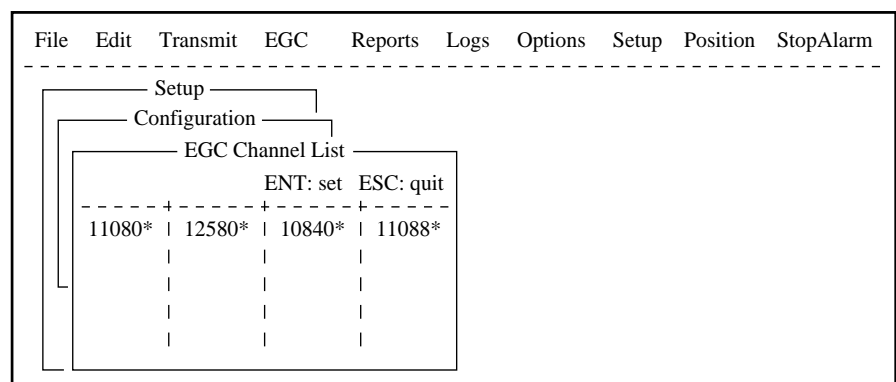

Figure 2-27 EGC channel list

4. Current EGC channels are marked with an asterisk. These channels cannot be changed.
5. With the arrow keys place the cursor where there is no data entered.

- Press [Enter] to open the text window.

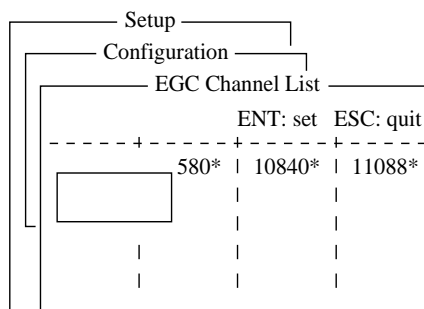

Figure 2-28 EGC channel list, cursor displayed

- Enter EGC channel frequency code.
- Press [Enter] to close the text window.
- Press [Esc] to open the update window.

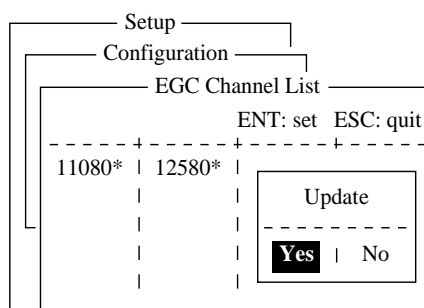

Figure 2-29 EGC channel list, update window

- Select “Yes” and press [Enter] to register input.

**Note:** The EGC channel frequency code range is 8000-14000. Any frequency code entered which is out of this range will display "Input Error: Channel No." Clear the error message by pressing the [Esc] key. Place the cursor at the invalid frequency. Then, press the [Enter] key and enter correct frequency.

## Programming NCS Channels

This section shows you how to add NCS channels to the NCS Channel List. Up to 19 channels can be listed per each ocean region. Currently, there are four NCS channels, and they are marked with asterisks in the list.

Below is the procedure for adding NCS channels, when they become available.

- Press [F8] to display the Setup menu.
- Press [9] to display the Configuration menu.
- Press [4] to display the NCS Channel List.

NCS Channel List								
ENT: set ESC: quit								
No	AOR (WEST)		AOR (EAST)		POR		IOR	
	ID	FREQ	ID	FREQ	ID	FREQ	ID	FREQ
1	044	11080*	144	12580*	244	12580*	344	10840*
2	0		1		2		3	
3	0		1		2		3	
4	0		1		2		3	
5	0		1		2		3	
6	0		1		2		3	
7	0		1		2		3	
8	0		1		2		3	

Figure 2-30 NCS channel list

4. Current NCS common channels are marked with an asterisk. These channels cannot be changed.
5. Place the cursor where there is no data entered.
6. Press [Enter] to open the text window.
7. Enter NCS channel ID number.
8. Press [Enter] to close the text window.
9. With [→] advance the cursor to the frequency column.
10. Press [Enter] to open the text window.
11. Enter NCS channel frequency code.
12. Press [Enter] to close the text window.
13. Press [Esc] to open the update window.

NCS Channel List								
ENT: set ESC: quit								
No	AOR (WEST)		AOR (EAST)		POR		IOR	
	ID	FREQ	ID	FREQ	ID	FREQ	ID	FREQ
1	044	11080*	144	12580*	244	12580*	344	10840*
2	0		1		2		3	
3	0		1		2		3	
4	0		1		2		3	
5	0		1		2		3	
6	0		1		2		3	
7	0		1		2		3	
8	0		1		2		3	

Update

Yes |  No

Figure 2-31 NCS channel list, update window

14. Press [Enter] to register input.

**Note:** The ID number range is 45-63 and the frequency code range is 8000-14000. Any ID or frequency entered which is out of those range will display "Input Error: NCS ID" (for invalid ID) or "Input Error: Channel No." (For invalid frequency). Clear the error message by pressing the [Esc] key. Place the cursor at the invalid ID or frequency code. Then, press the [Enter] key and enter correct ID or frequency.

15. Press [Esc].

# LES List Operations

The LES List provides for storage of 44 LES names per ocean region. When the LES table is opened on the Send menu, LES names entered in this LES List appear along with their IDs. See page 2-21.

## Programming the LES list

1. Press [F8] to display the Setup menu.

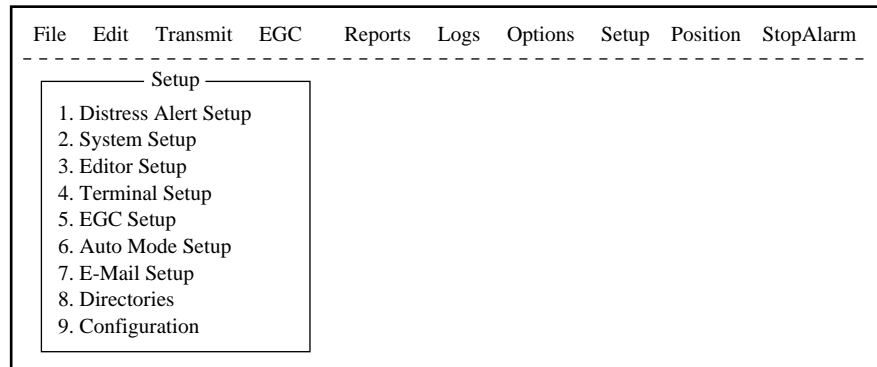

Figure 2-32 Setup menu

2. Press [9] to display the Configuration menu.

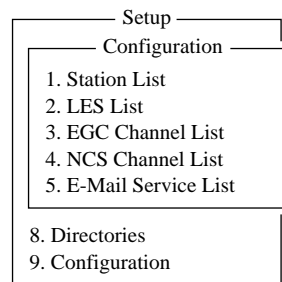

Figure 2-33 Configuration menu

3. Press [2] to display the LES List.

The screenshot shows the 'LES List' table with the following data:

No	AOR (WEST) Name	AOR (EAST) Name	POR Name	IOR Name
1	SOUTHBURY	SOUTHBURY	SANTA PAULA	
2	GOONHILLY	GOONHILLY		
3			YAMAGUCHI	YAMAGUCHI
4				EIK
5		FUCINO		THERMOPYLAE
6				ARVI
7				
8			KUMSAN	KUMSAN

Figure 2-34 LES list



4. With the arrow keys place the cursor where no data is entered.
5. Press [Enter].

LES List				
Ctrl+P: print    ENT: list entry    ESC: quit				
No	AOR (WEST) Name	AOR (EAST) Name	POR Name	IOR Name
1	SOUTHBURY			
2	GOONHILLY			
3				YAMAGUCHI
4				EIK
5				THERMOPYAE
6				ARVI
7				
8			KUMSAN	KUMSAN

Name :  
 ID :  
 Remarks :  
 -----  
 Erase the Name to delete this LES.

Figure 2-35 LES list, LES entry window

6. Press [Enter] to open the text window.

Name :   
 ID :   
 Remarks :  
 -----  
 Erase the Name to delete this LES.

Figure 2-36 LES list, text window

7. Enter LES name (maximum 15 characters).
8. Press [Enter].
9. Press [ ↓ ] to advance the cursor to the ID line.
10. Press [Enter].
11. Enter LES ID. The table on page 2-21 shows all current LES IDs.
12. Press [Enter].
13. Press [ ↓ ] to send the cursor to the Remarks line.
14. If desired, enter remarks (up to 20 characters).
15. Press [Esc] to register LES.
16. To return to the standby display, press [Esc] three times.

## Deleting and changing the LES list

1. Press [F8], [9] and [2] to display the LES list.
2. Select the LES you want to edit.
3. Press [Enter].  
The cursor should be on the Name line.

```
Name : Yamaguchi
ID   : 303
Remarks : KDD Japan.....
-----
Erase the Name to delete this CES.
```

Figure 2-37 LES selected from LES list

4. Press [Enter] again to open the window for name entry.
5. To delete/change the LES name, press [Backspace] to erase name and then press [Enter].
6. To edit an entry, place the cursor on the item you want to edit, press [Enter], delete with the [Backspace] key, then enter new data.
7. Press [Esc] to save changes.
8. To return to the standby display, press [Esc] twice.

## Printing the LES list

1. Press [F8], [9] and [2] to display the LES list.
2. While pressing and holding down [Ctrl], press [P] to print the LES list.

```
-----
LES List ( Printed at 97-08-04 02:33 )

+++++ AOR (WEST) +++++
No. Name      LES ID   Remarks
01  SOUTHBURY  001     USA
02  GOONHILLY  002     UK (NCS, ID044)
12  STATION12  012     NETHERLANDS

+++++ AOR (EAST) +++++
No. Name      LES ID   Remarks
01  SOUTHBURY  101     USA
```

Figure 2-38 Sample LES list printout

3. To return to the standby display, press [Esc] three times.

*Table 2-1 LES IDs*

Land earth station operator	Country	AOR- E	AOR- W	IOR	POR
Beijing Marine	China			311	211
Bezeq	Israel	127		327	
CAT	Thailand			319	
CP Radio Marconi	Portugal	118			
Embratel	Brazil	114			
France Telecom	France	121	021	321	221
France Telecom (Ex DeteSat)	France	115		333	
KDDI	Japan	103	003	303	203
Korea Telecom	South Korea			308	208
Morviasputnik (Nudel Les)	Russia	117		317	
OTE	Greece	120		305	
Polish Telecom	Poland	116		316	
Saudi Telecom Co	Saudi Arabia	125		325	
Singapore Telecom	Singapore			328	210
Stratos Mobile Networks	Canada	102	002	302	202
Telecom Company of Iran	Iran			314	
Telecom Italia	Italy	105		335	
Telenor Satellite Services Inc	USA	101	001		201
Telenor Satellite Services AS	Norway	104	004	304	204
Turk Telecom	Turkey	110		310	
Vishipel	Vietnam			330	
VSNL	India			306	
Xantic	Netherlands	112	012	312	212
Xantic	Australia	122	022	322	222

# Station List Operations

## Programming the station list

The FELCOM 12 provides an “address book” for programming 64 station IDs.

1. Press [F8] to display the Setup menu.
2. Press [9] to display the Configuration menu.
3. Press [1] to display the Station List.

Station Name	Type	Code, ID / Address
01 abc	E-Mail	abc@ furuno.co.jp
02 xyz	E-Mail	xyz@ furuno.co.jp
03 Seagull	TELEX	584 463609999
04		
05		
06		
07		
08		

Figure 2-39 Sample station list

4. Operate [ ↓ ] to place the cursor on a blank line.
5. Press [Enter].

<b>Station Name</b>
Destination Type   TELEX
Prefix Code
Country Code
Station ID
Modem Type
E-Mail Address
Remarks
-----
Erase the Name to delete this station.

Figure 2-40 Entering a station

6. Press [Enter] to open the window for station name entry.
7. Enter name of station, using up to 15 characters.
8. Press [Enter] to close the window.
9. Press [ ↓ ] to send the cursor to the Destination Type line.

10. Press [Enter] to open the destination type window.

TELEX
FAX
E-Mail
CSDN
PSDN
X400
DNID
SPEC
TELEX (Prefixed)
FAX (Prefixed)
PSDN (Prefixed)
X400 (Prefixed)
DNID (Prefixed)
SPEC (Prefixed)

Figure 3-41 Selection window for “destination type”

**TELEX:** Telex communication

**FAX:** Facsimile service  
- to an office facsimile machine

**E-Mail:** E-mail (electronic mail) Service

**CSDN:** Circuit Switched Data Network-not used.

**PSDN:** Packet Switched Data Network  
-to an office computer via a data network using X.25 standard.

**X400:** For future use

**DNID:** Data Network ID -not used.

**SPEC:** Ship-to shore requests for safety service, accessed by using special 2-digit codes (See Note 2 below.)

**Note 1:** When FAX is selected, select “T30 (FAX)” in the “Modem Type” selection display. For further details, refer to page 4-2.

**Note 2:** When SPEC is selected on the Type line, the Country Code line disappears. Enter two-digit codes on the Station ID line. Refer to page 4-18 for further details.

11. Set up according to Destination Type selection. The steps which follow show how to set up for TELEX (Prefixed).

12. Press [Enter] to close the destination type window.

13. [ ↓ ] to advance the cursor to the Prefix Code line for prefixed.

14. Press [Enter] to open the prefix code window.

15. Key in prefix code in two digits.

Note that some services may not be available depending on LES.

Prefix Code	Function
11	Operator's Assistance
12	Dial Guide
33	Technical Assistance
91	Automatic Telex Test
⋮	⋮

16. Press [Enter] to close the prefix code window.
17. Press [ ↓ ] to advance the cursor to the Country Code line for TELEX, FAX, PSDN.
18. For ship-to-shore telex, enter international telex country code; ship-to-ship telex, enter ocean region. A list of international telex country codes begins on page A-1 in the Appendix.

Ocean Region

AOR-East: 581  
 POR: 582  
 IOR: 583  
 AOR-West: 584

19. Press [Enter] to close the window.
20. Press [ ↓ ] to send the cursor to the Station ID line.
21. Press [Enter] to open the window for station ID entry.
22. Enter telex subscriber number (for land) or MES Inmarsat Mobile Number (for ship).  
 Up to 15 characters, including space, can be entered.
23. Press [Enter] to close the window.
24. Press [ ↓ ] to advance the cursor to the Remarks line.
25. Press [Enter] to open the window for remarks entry.
26. If desired, enter remarks (up to 20 characters).
27. Press [Enter] to close the window.
28. To return to the standby display, press [Esc] three times.

## Editing the station list

1. Press [F8], [9] and [1] to display the Station List.

Station Name	Type	Code, ID / Address
01 abc	E-Mail	abc@ furuno.co.jp
02 xyz	E-Mail	xyz@ furuno.co.jp
03 Seagull	TELEX	584 463609999
04		
05		
06		
07		
08		

Ctrl+P: print

*Figure 2-42 Station list*

2. Press [ ↓ ] and [Enter] to select the station you want to edit.
3. Press [Enter] to open the station name window.
4. To delete a station, press [Backspace] to erase station name, and then press [Enter].
5. To edit a station name, place the cursor on the character you want to edit. Press [Backspace] to erase that character, then enter correct character.
6. Press [Enter] to save changes.
7. If necessary, select other item, edit it and press [Enter].
8. To return to the standby display, press [Esc] four times.

## Printing the station list

1. Press [F8], [9] and [1] to display the Station List.
2. While pressing and holding down [Ctrl], press [P].

No.	Name	Type	Dest, ID, Modem / Address	Remarks
01	abc	E-Mail	abc@ furuno.co.jp	
02	xyz	E-Mail	xyz@ furuno.co.jp	
03	Seagull	TELEX	584 463609999	

*Figure 2-43 Sample station list printout*

3. To return to the standby display, press [Esc] three times.

# Entering Own Ship's Position

When there is no navigation device connected, select OFF on the Nav Port line in the System Setup menu, as explained on page 2-4, and enter ship's position manually as follows:

1. Press [F9] to display the Position menu.

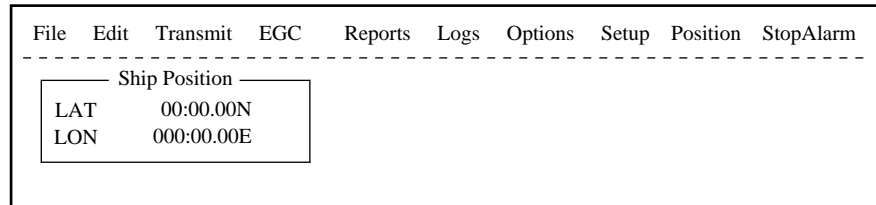

Figure 2-44 Ship position

2. Press [Enter] to open the window for latitude entry.

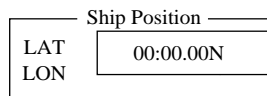

Figure 2-45 Ship position, window for entering position

3. Enter latitude and [N] or [S].
4. Press [Enter] to close the window.
5. Press [↓] to send the cursor to the LON line.
6. Press [Enter] to open the window for longitude entry.

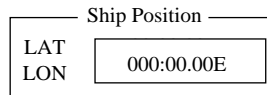

Figure 2-46 Ship position

7. Enter longitude and [E] or [W].
8. Press [Enter] to close the window.
9. Press [Esc] to open the update window.

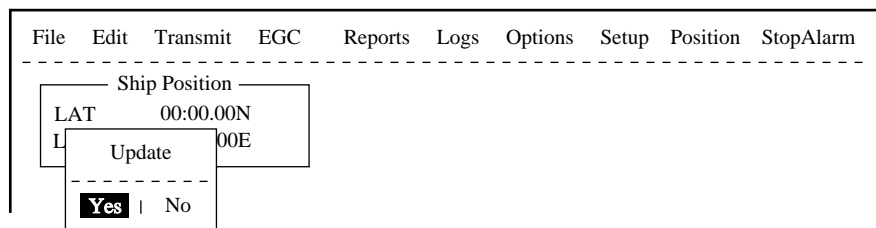

Figure 2-47 Ship position, update

10. Press [Enter] to close Ship Position menu.

This position data is also entered on the "Update Distress Alert" screen. (Refer to page 6-1.)



# Setting Directories

You can designate the directory where to save incoming and outgoing messages as follows:

1. Press [F8] to display the Setup menu.
2. Press [8] to display the Directories menu.

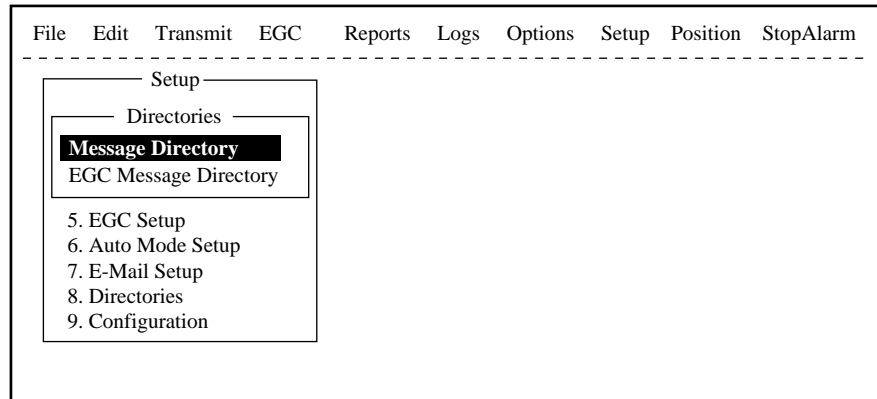

Figure 2-48 Setup menu, directories

3. Press [Enter] to select “Message Directory”.  
Message Directory appears in the command line.

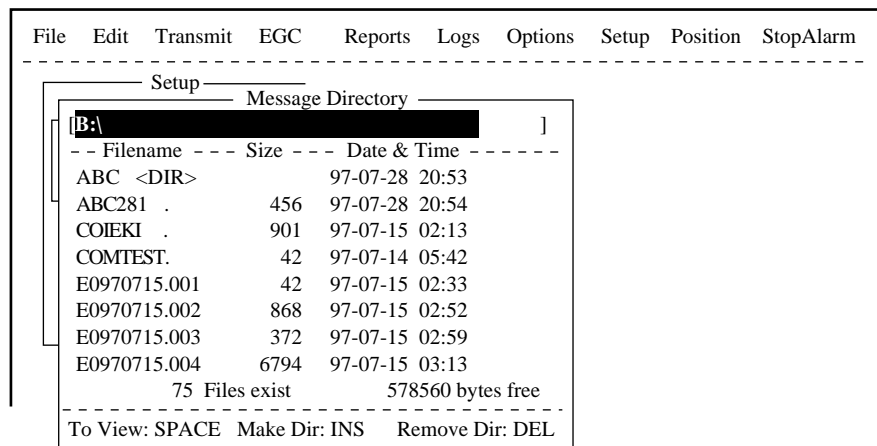

Figure 2-49 Setup menu, directories, message directory

4. Press [ ↓ ] to select a directory name.
5. Press [Insert] to make a new directory name.
6. Type a new directory name (for example, MESSAGE).
7. Press [Enter].
8. Press [ ↑ ] .
9. Press [Enter] to select directory name.
10. Press [Esc] twice to return to standby.

# E-mail Service List

The E-mail service list provides for E-mail set up. Currently there are four service stations which handle E-mail. The procedure below describes how to add service stations to the list.

1. Press [F8] to display the Setup menu.
2. Press [9] to display the Configuration menu.

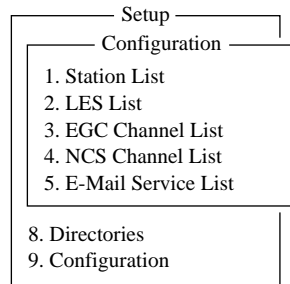

Figure 2-50 Setup menu, configuration

3. Press [5] to display the E-mail Service List.

	Station Name	AOR.W	AOR.E	POR	IOR
01	Comsat	001	101	201	321
02	PTT Telecom	012	112	212	312
03	British Telecom	002	102	202	302
04	Stratos	022	122	222	322
05	Telstra	022	122	222	322
06	EIK	004	104		304
07					
08					

Figure 2-51 Setup menu, configuration, E-Mail Service List

4. Select blank space in Station Name column and press [Enter]. E-mail setup display appears.

Figure 2-52 E-mail setup

5. Press [Enter] to open the window for service station name entry.

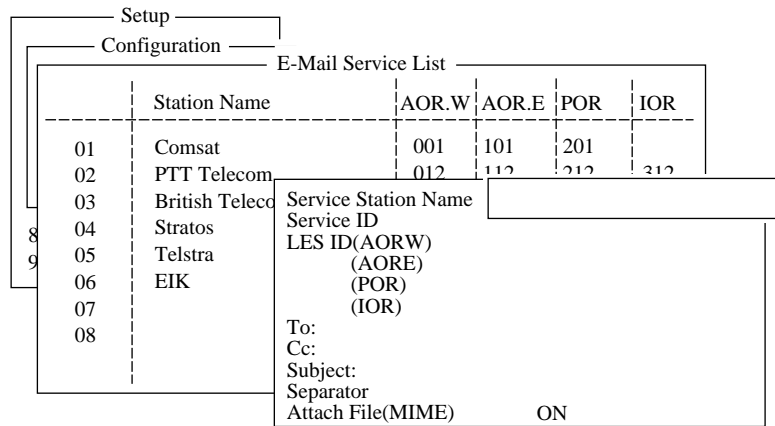

Figure 2-53 Service station list

6. Type service station name.
7. Press [Enter] to close the window.
8. Press [ ↓ ] to place the cursor on the Service ID line.
9. Press [Enter] to open the window for service ID entry.
10. Type Service ID.  
Service ID is station address .
11. Press [Enter] to close the window.
12. Press [ ↓ ] to place the cursor on the LES ID line.
13. Press [Enter] to open the window for LES ID entry.
14. Type LES ID of AOR-W.
15. Press [Enter] to close the window.
16. Follow steps 12 thru step 15 for AOR-E, POR and IOR.
17. Press [ ↓ ] to place the cursor on the “To:” line.
18. Press [Enter] to open the window for “to” header entry.
19. Type proper “To” header (for example, TO:, to+, etc.).
20. Press [Enter] to close the window for “cc” header entry.
21. Press [ ↓ ] to place the cursor on the “Cc:” line.
22. Press [Enter] to open the window for “cc” header entry.
23. Type proper “Cc” header (for example, CC:, cc+, etc.).
24. Press [Enter] to close the window for “subject” header entry.
25. Press [ ↓ ] to place the cursor on the “Subject:” line.
26. Press [Enter] to open the window for “subject” header entry.
27. Type proper “Subject” header (for example, Subject:, subject+, etc.).
28. Press [Enter] to close the window for separator entry.

29. Press [ ↓ ] to place the cursor on the “Separator” line.
30. Press [Enter] to open the window for separator entry.
31. Type proper Separator (for example, blank space, STX:, etc.).
32. Press [Enter] to close the window.
33. Press [ ↓ ] to place the cursor on the “Attach File (MIME)” line.
34. Press [Enter] to open the selection window.
35. Select “ON(BASE64)”, “ON(UUENCODE)” or “OFF”.
  - BASE64: General text converter
  - UUENCODE: Win/UNIX text converter
36. Press [Enter] to close the selection window.
37. Press [Esc] three times to return to the standby display.

## E-mail Setup

Select the LES where to forward E-mail. Also, you will need to register with the LES to get E-mail services.

1. Press [F8] to display the Setup menu.
2. Press [7] to display E-mail Setup screen.

Setup		E-Mail Setup			
	Station Name	AOR.W	AOR.E	POR	IOR
01	Comsat	001	101	201	

6. Auto Mode Setup
7. E-Mail Setup
8. Directories
9. Configuration

Figure 2-54 E-mail Set up display

3. Press [Enter] to open the selection window.

Setup		E-Mail Setup			
	Station Name	AOR.W	AOR.E	POR	IOR
01	Comsat	001	101	201	321
02	PTT Telecom	012	112	212	312
03	British Telecom	002	102	202	302
04	Stratos	022	122	222	322
05	Telstra	022	122	222	322
06	EIK	004	104		304
07					
08					

Figure 2-55 E-mail Operating LES

4. Selecter the LES where to forward E-mail.

5. Press [Enter] to the update window.

The screenshot shows a terminal window with a menu titled "E-Mail Setup" under a "Setup" header. The menu lists stations with columns for Station Name, AOR.W, AOR.E, POR, and IOR. An "Update" dialog box is overlaid on the screen, containing a "Yes" button and a "No" button. The "Yes" button is highlighted with a black background.

	Station Name	AOR.W	AOR.E	POR	IOR
01	Comsat	001	101	201	
02	PTT Telecom	012	112	212	312
03	British Telecom	002	102	210	
04	Stratos	022	101		22
05	Telstra				
06	EIK				
07					
08					

Update

Yes | No

Figure 2-56 update window

6. Press Enter again.

7. Press ESC to return the stand by display.

This page is intentionally left blank.



**Note:** *If the text editor screen does not appear and “close” screen appears, see “Opening a file where a working area is occupied” on page 3-11.*

3. The cursor is on the first line. Type your message.

## Preparing a confidential message

If communicating with another FELCOM 12, you can prepare a confidential message by entering “S???-addressee code(-password):” in first line of message text. You can also receive confidential messages containing this header from a land subscriber or any MES which uses the FELCOM 12.

There are two types of confidential messages: message with addressee code and message with both addressee code and password.

When a FELCOM 12 receives a confidential message, the message is not displayed and printed immediately. To display or print the contents of a confidential message, the recipient executes the key sequences shown on page 4-23.

### Explanation of addressee code and password

Caller and recipient agree beforehand on both the addressee code and the password. The addressee code can be the title of the recipient; for example, CAPTAIN. The password could be the classification of the message; for example, SECRET.

#### Preparing message with addressee code

Type S, 3 question marks, hyphen, addressee code, colon followed by text of message.

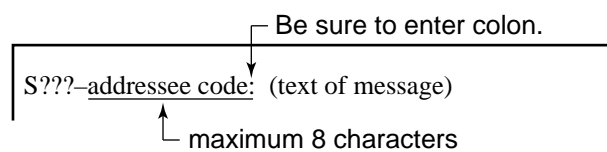

*Figure 3-3 Addressee code*

#### Preparing message with both addressee code and password

Type S, 3 question marks, hyphen, addressee code, hyphen, password, colon followed by text of message.

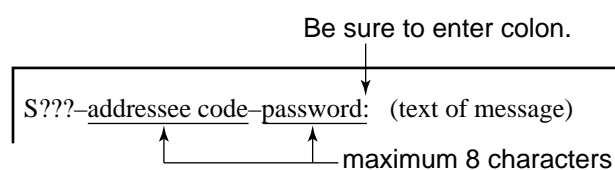

*Figure 3-4 Addressee code and password*



When the recipient receives a message with both addressee code and password, he must enter the password to view contents of the message.

## Editor menu setup

The Editor menu sets the parameters of the text editor.

1. Press [F8] to display the Setup menu.
2. Press [3] to display the Editor Setup menu.

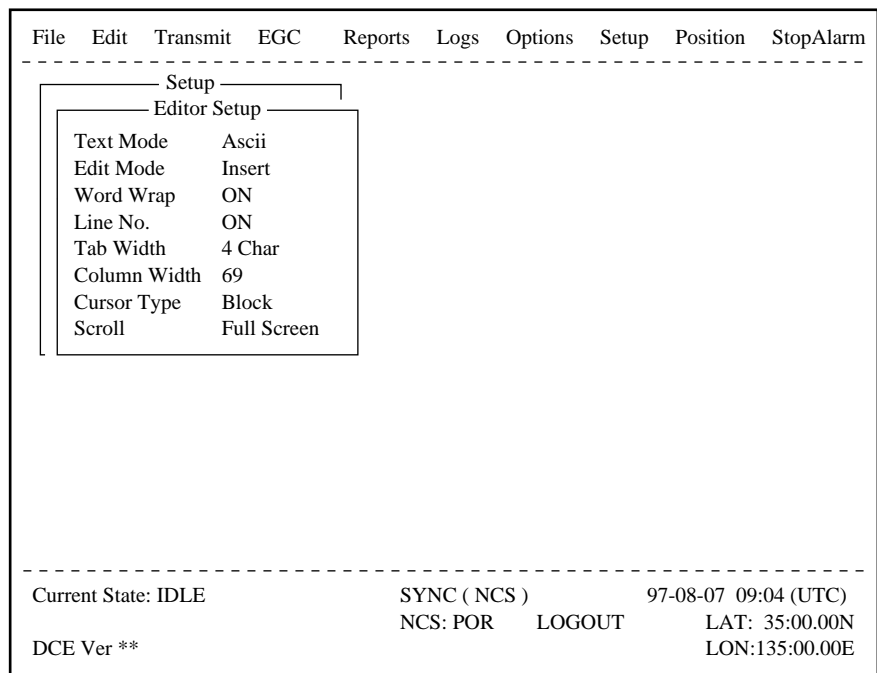

*Figure 3-5 Editor setup menu*

3. Figure 3-5 shows the default editor setup settings. To change settings, select item with arrow keys, press [Enter] to open selection window, and select settings with arrow keys. After selecting settings, press [Enter].

**Text Mode:** Select “Telex” or “ASCII”.

**Edit Mode:** Select “Insert” (insert character at cursor location) or “Overwrite” (write over character at cursor location).

**Word Wrap:** Turns on/off hyphenation at end of line.

**Line No.:** Turns line number display on or off.

**Tab Width:** Sets horizontal tab width; 2, 4 or 8 tabs per line.

**Column Width:** Select Telex (69 Fixed) or ASCII (40 to 80).

**Cursor Type:** Selects cursor appearance, either ■ (Block) or underline.

**Scroll:** Sets how much the screen moves up over the page (Full Screen or Half Screen) when [PgUp] or [PgDn] key is operated.

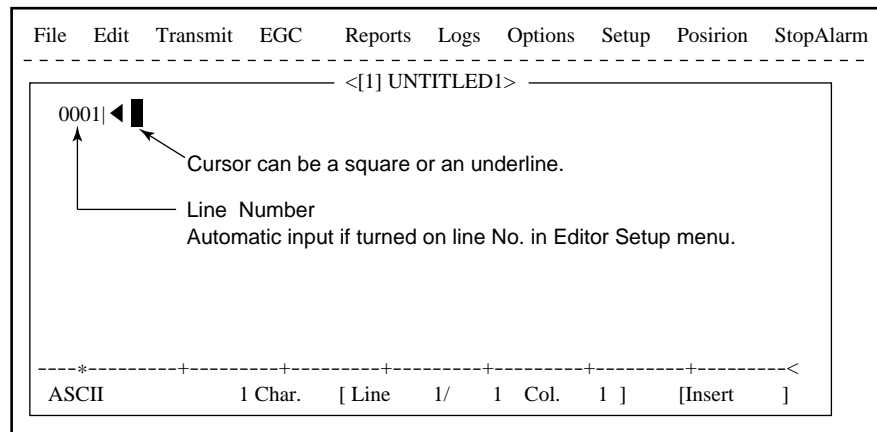

*Figure 3-6 Text editor screen*

## Cutting and pasting text

1. Place the cursor on the first character of the text to be cut.
2. Highlight the text to be cut by pressing [→] while pressing and holding [Shift]. You can use the right and left arrow keys to adjust the highlight. The figure below shows the appearance of highlighted text.

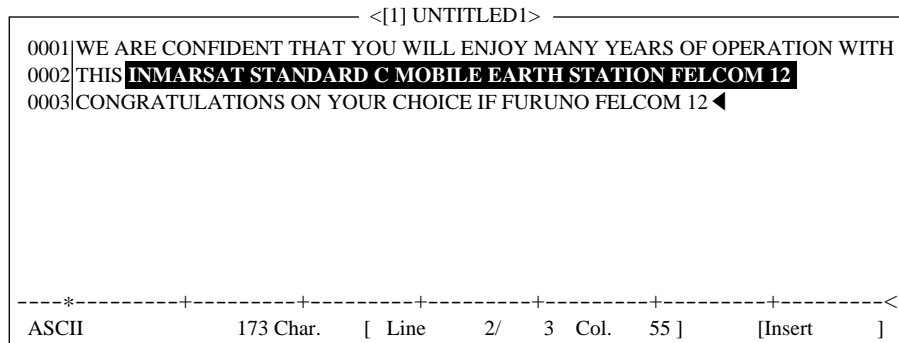

*Figure 3-7 Appearance of highlighted text*

3. Press [F2] to select the Edit menu.

Edit	
1. Cut	DEL
2. Copy	ALT-C
3. Paste	INS
4. Insert (With Citation)	
5. Select All	ALT-A
6. Search or Replace	
7. Goto Line	
8. Time or Pos. Ins	
9. Change Window	ALT-V

*Figure 3-8 Edit menu*

4. Press [1] to select Cut. The highlighted text is cut and the remaining text is reformatted. If a mistake is made, you can immediately restore the text by pressing [Insert].
5. To move text to a new location after it has been cut, place the cursor at the exact spot in the message where the cut text is to start. When the text cursor is placed correctly, press [F2] and then [3] (Paste).

## Copying and pasting text

1. Select the text you want to copy.

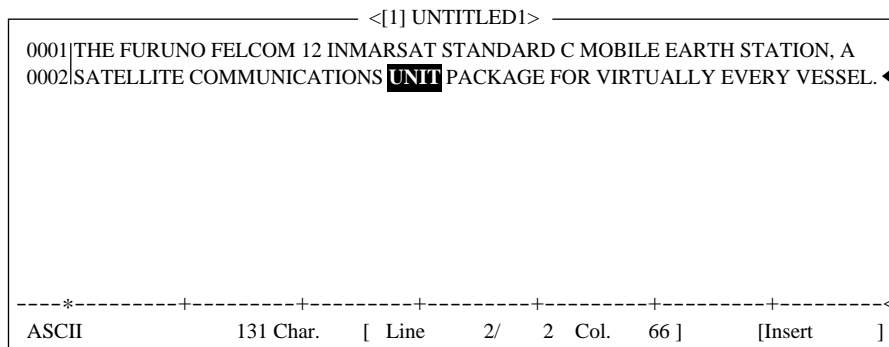

*Figure 3-9 Appearance of highlighted text*

2. Press [F2] to display the Edit menu.
3. Press [2] to select Copy. The text selected is copied to the internal clipboard.
4. Place the cursor at the exact spot on the message where the copied text is to start.

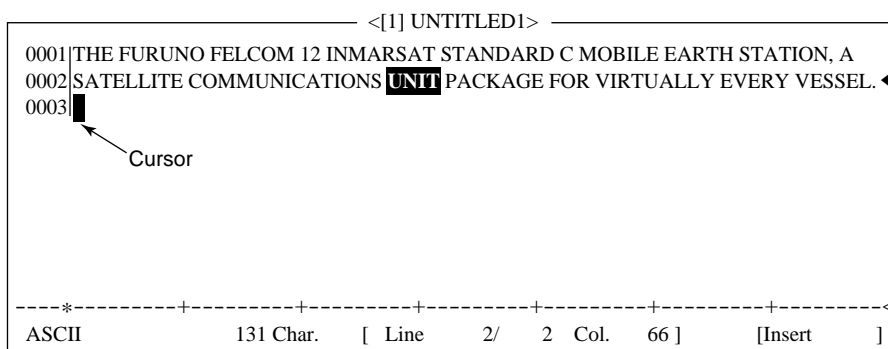

*Figure 3-10 Cursor selects location where to paste text*



# Saving a Message

## Formatting a floppy disk

To save a message to a floppy disk the disk must be formatted. Formatting prepares the disk so information can be written to its surface.

1. Insert a blank floppy disk into the disk drive.
2. Press [F1].
3. Press [8].

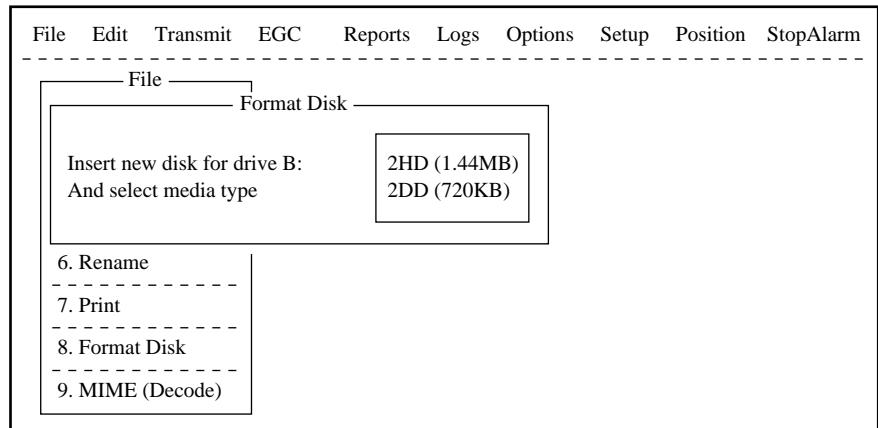

Figure 3-12 Format disk screen

4. Select media type.
5. Press [Enter].

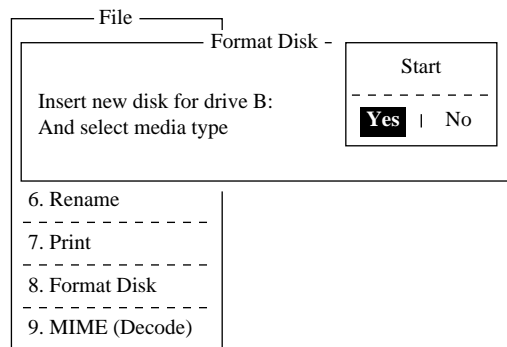

Figure 3-13 FD Format confirmation screen

6. Select "Yes" to format the disk. Press [Enter] to begin formatting.

**Note:** If there is no floppy disk in the drive, "FD not inserted in drive. Press any key to escape." appears on the display.

7. "Now Formatting" appears on the screen during formatting.
8. When formatting is completed (about one minute), "Formatting Completed." appears on the display. You can now return to the standby display by pressing any key.

## Saving a message

You can save a message two ways: Save it without losing your place on the screen (called “save”), or save it before clearing the screen (called “close”).

### Save message, retain place on screen

1. Press [F1] to display the File menu.
2. Press [4]. The screen should look something like Figure 3-14.

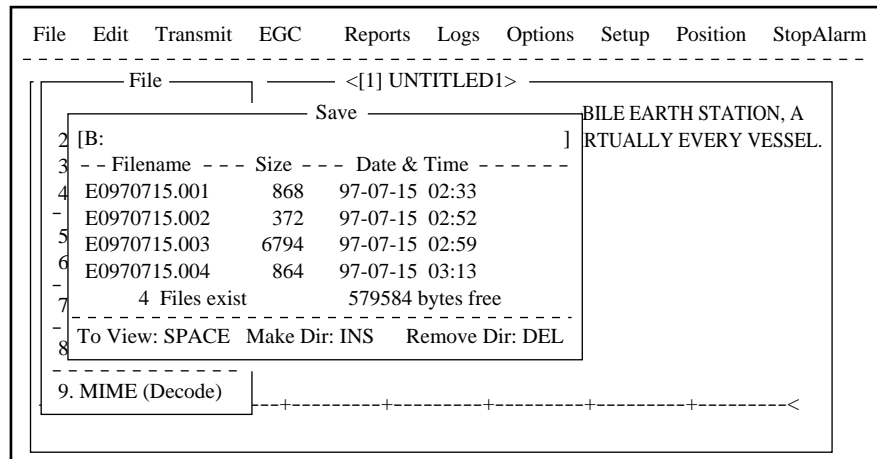

*Figure 3-14 Save screen*

3. Enter a file name, up to eight characters with extension name (three characters), as shown below.

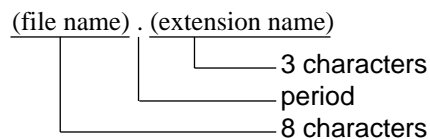
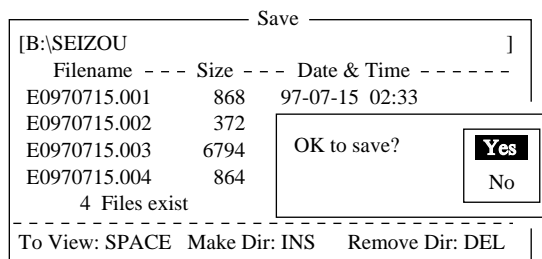
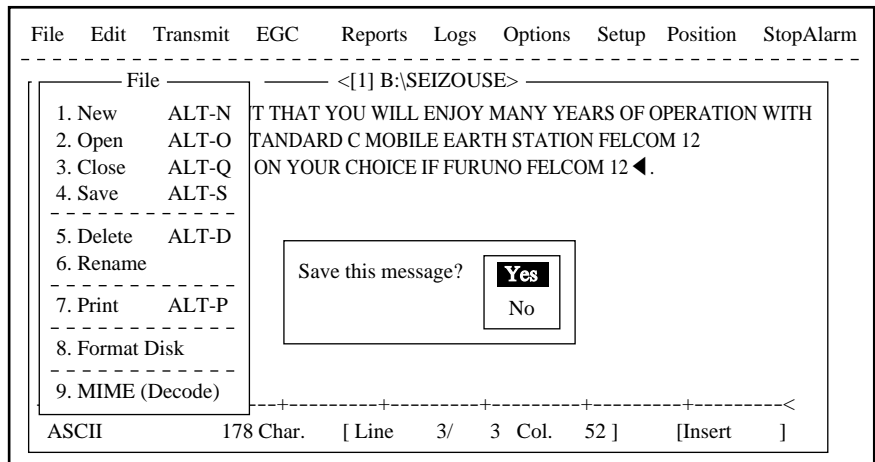

*Figure 3-15 Configuration of file menu*

4. Press [Enter]. “SAVING” appears on display.

## Save message, clear screen

1. Press [F1] to display the File menu.
2. Press [3]. The prompt “Save this message?” appears on the screen.



*Figure 3-16 File menu, close file prompt*

3. Press [Enter].

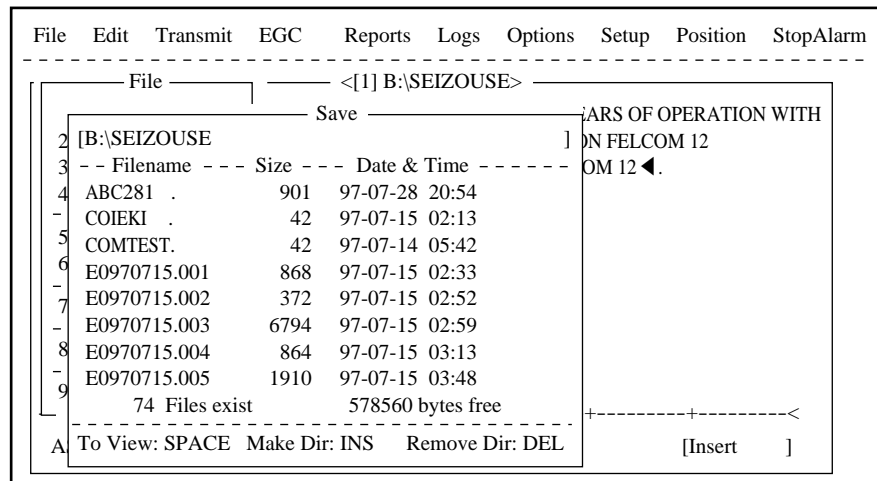

*Figure 3-17 Save screen*

4. Enter a file name.
5. Press [Enter].

## Opening a File

The internal memory provides two working areas where you can load one file each. Only one file can be displayed at a time, however you can easily switch between files.

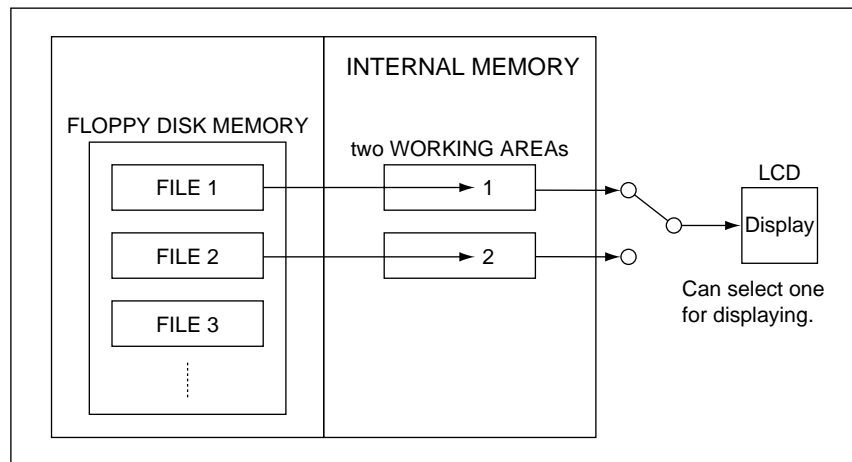

Figure 3-18 Internal memory

## Opening a file

1. Set the floppy disk containing the file you wish to open in the disk drive.
2. Press [F1] to display the File menu.
3. Press [2]. The screen shows a list of the files stored in the floppy disk.
4. Select a file.  
To view a portion of a file, press the space bar.

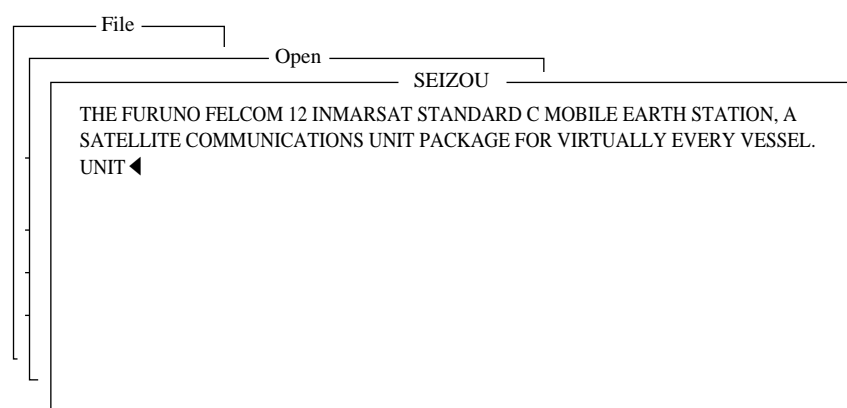

Figure 3-19 Partial view of a file

5. Press [Enter].
6. The message "Loading" appears on the screen during loading. A few moments later the contents of the file appear on the screen and the title bar shows the file name. You may repeat the above procedure to load a second file into a working area.



## Switching between files

You can switch between files by selecting Change Window in the Edit menu. Figure 3-20 illustrates how to switch between files with Change Window.

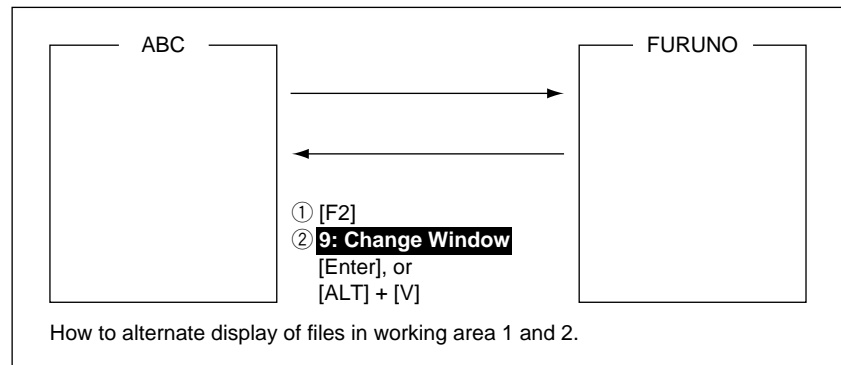

Figure 3-20 How the change window feature works

## Opening a file where a working area is occupied

When you try to load a file into an occupied working memory, the display asks you if you want to save the file in that memory before clearing the display.

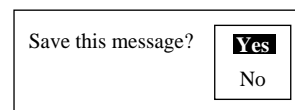

Figure 3-21 Prompt for closing a file

To save the file, press [Enter]; select “No” and press [Enter] if you do not need to save the file. The file screen is erased and then the untitled window appears.

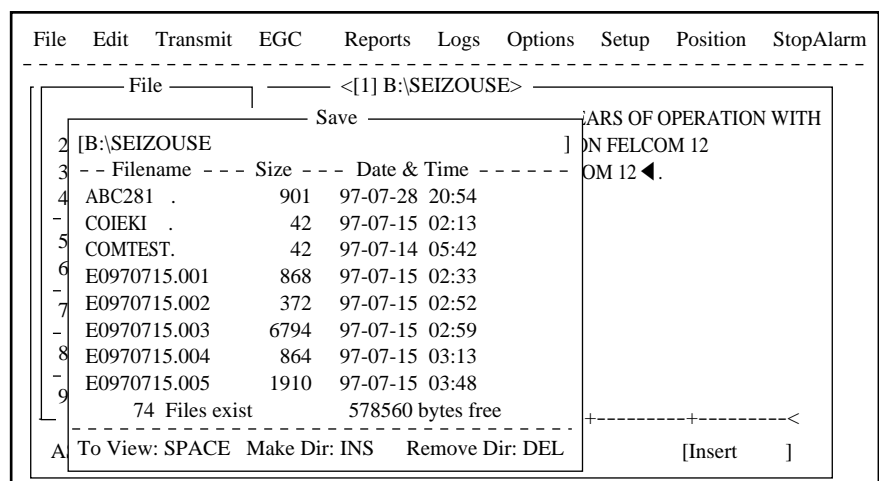

Figure 3-22 Save screen

Enter file name followed by [Enter]. The editing screen appears.

# Saving a File Under a New Name

1. Call up a file.
2. Edit the file.
3. Press [F1].
4. Press [3] (or [4]). “Save this message?” prompt appears. [3] saves file and closes screen; [4] saves file and keeps position on screen.

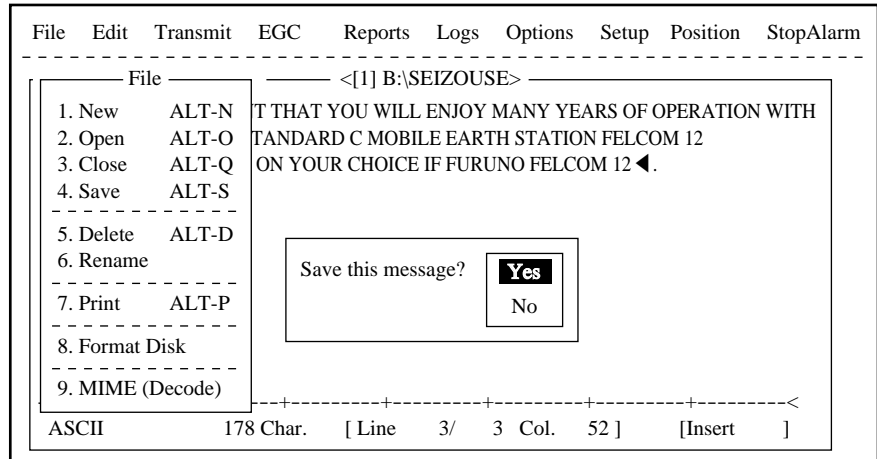

Figure 3-23 Save screen, prompt for saving a message before closing

5. Press [Enter].
6. Press [Backspace] to delete original file name. Enter file name for new file.

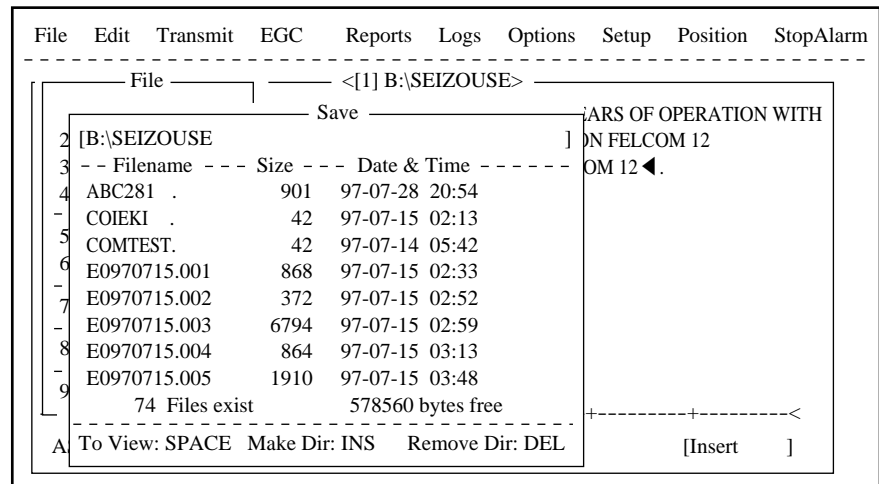

Figure 3-24 Save screen

7. Press [Enter].

**Note:** Should you decide to save the file under the original name, skip step 6. The following screen appears.

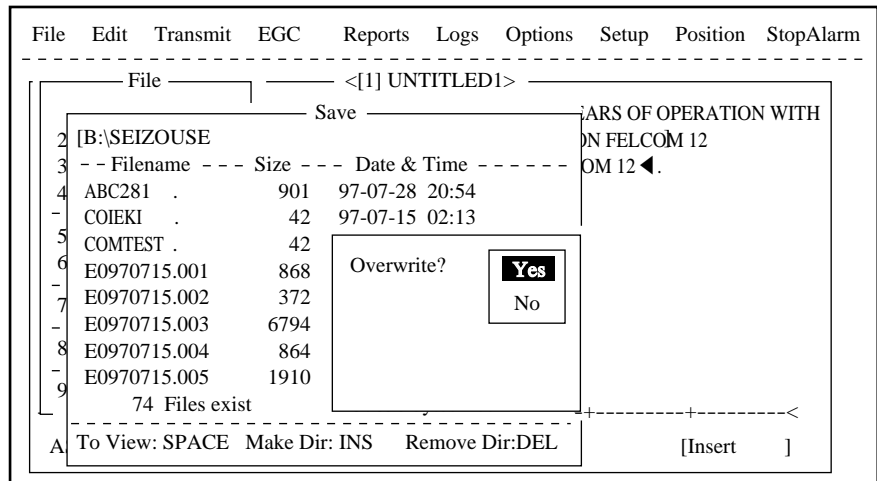

Figure 3-25 Save screen, overwrite file name

## Printing a File

You can print out a hard copy of a file stored in a floppy disk.

1. Press [F1] to display the File menu.
2. Press [7]. A list of files stored on the disk appears.

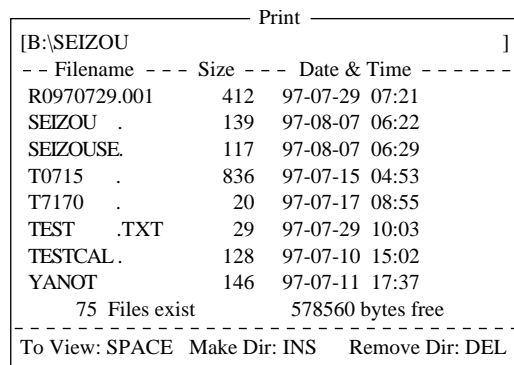

Figure 3-26 Sample print screen

3. Select a file. To get a partial display of the file, tap the space bar.
4. Press [Enter].

## Combining Files

In the procedure below we'll combine file A and B.

1. Open file A.
2. Open file B. File B appears on the display.
3. Place the cursor at the beginning of the file. While pressing and holding down [Shift] press [ ↓ ] to highlight the entire file. (You can also select a portion of the file.)
4. Press [C] while holding down [Alt]. This places file B on the clipboard.
5. Press [V] while holding down [Alt]. File B is erased and File A appears on the display.
6. Press [→] while holding down [Fn] followed by [Enter] to place the cursor at the end of the file.
7. Press [Insert].  
The file B is inserted at the end of the file A.

## Deleting a File

1. Press [F1] to display the File menu.
2. Press [5]. A list of files stored on the disk appears.

Filename	Size	Date & Time
ABC28	901	97-07-28 20:53
ABC281	901	97-07-28 20:54
COIEKI	42	97-07-15 02:13
COMTEST.	42	97-07-14 05:42
E0970715.001	868	97-07-15 02:33
E0970715.002	372	97-07-15 02:52
E0970715.003	6794	97-07-15 02:59
E0970715.004	864	97-07-15 03:13

75 Files exist 578560 bytes free

To View: SPACE Make Dir: INS Remove Dir: DEL

*Figure 3-27 Sample delete screen*

3. Select the file you want to delete. To verify the contents of that file, tap the space bar.

4. Press [Enter]. The prompt “OK to delete file?” appears.

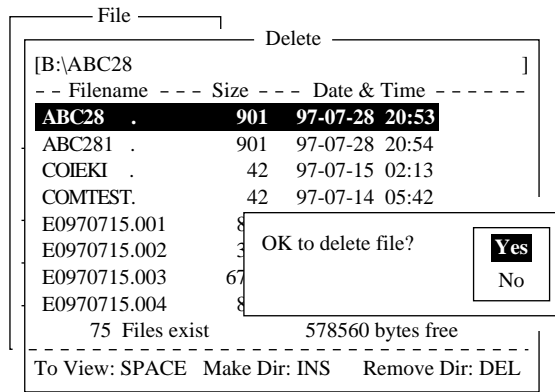

Figure 3-28 Prompt for verification of file delete

5. Press [Enter] to delete the file, or press [ ↓ ] and [Enter] to escape.

## MIME (Multipurpose Internet Mail Extensions)

When you can't read an attached file in the Log menu, you may decode it with MIME as follows:

1. Press [F1].
2. Press [9].

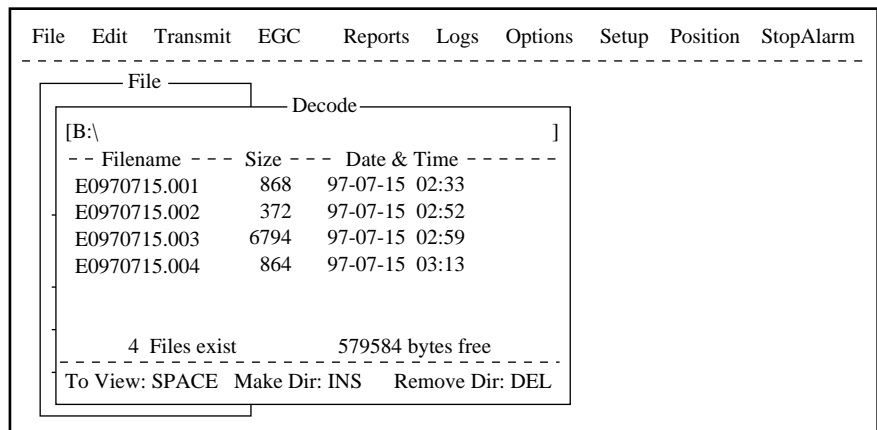

Figure 3-29 File, decode

3. Select the file you want to decode.
4. Press [Enter].

# Rename

Do the following to change file name.

1. Press [F1].
2. Press [6].

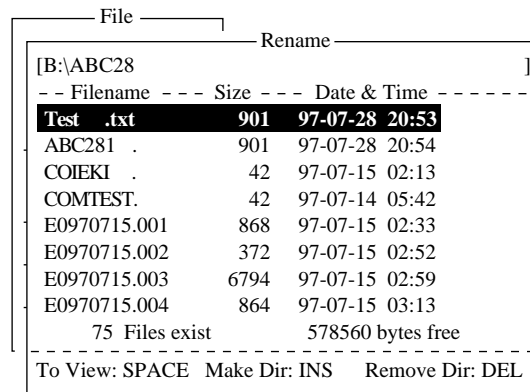

Filename	Size	Date & Time
Test .txt	901	97-07-28 20:53
ABC281 .	901	97-07-28 20:54
COIEKI .	42	97-07-15 02:13
COMTEST.	42	97-07-14 05:42
E0970715.001	868	97-07-15 02:33
E0970715.002	372	97-07-15 02:52
E0970715.003	6794	97-07-15 02:59
E0970715.004	864	97-07-15 03:13

75 Files exist 578560 bytes free

To View: SPACE Make Dir: INS Remove Dir: DEL

*Figure 3-30 File, rename*

3. Select a file you want to rename.
4. Press [Enter].

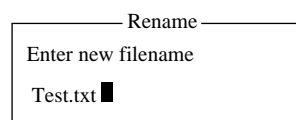

Rename

Enter new filename

Test.txt █

*Figure 3-31 Rename window*

5. Delete old file name and then type new file name.
6. Press [Enter].

# **INMARSAT-C COMMUNICATIONS**

---

This chapter explains how to transmit and receive in the Inmarsat-C system.

Before conducting any communications, be sure to login with the NCS in your area.

To transmit E-mail, register with the LES provider. E-mail charges are calculated separately.

## **Transmitting**

To transmit a message, you first create the message, attach the address of the recipient and send it to the LES. The address of the recipient in the Inmarsat-C system is his telex number for land-line or MES Inmarsat Mobile Number (IMN) for ship.

The message can be one you've just prepared or one stored on a floppy disk. (Messages cannot be transmitted by means of direct keyboard input.)

### **Code description**

Code can be specified at the IB-581 or PC.

IA5: International alphabet No. 5, ASCII code (7 bit).  
Specify this code to transmit English containing lower case alphabet.

ITA2: No. 2 international communications alphabet (5 bit).  
Specify this code for message which contains only No. 2 international communications alphabet (see A-11). ITA2 code is transmitted faster than IA5 code.  
Land-based telex equipment uses ITA2. The LES converts all codes into ITA2. Code which cannot be converted is shown with a question mark (?).

DATA: Data (8 bit). Use this code to transmit data.

*Table 4-1 Message, subscriber destination and code*

Message	Subscriber	Destination Type	Code	Remarks
English	Inmarsat C Sta.	TELEX	IA5	
	Telex	TELEX	ITA2	
	Fax	PSTN	IA5	Modem type is T30 FAX.
	E-mail	E-Mail	IA5	
Russian	Inmarsat C Sta.	PSDN	DATA	
	Telex	TELEX	ITA2	THERMOPYLAE (305) and PEATH (222)
	Fax	Not available		
	E-mail	E-Mail	DATA	
Japanese	Inmarsat C Sta.	PSDN	DATA	
	Telex	Not available		
	Fax	Not available		
	E-mail	E-Mail	DATA	
Data	Inmarsat C Sta.	PSDN	DATA	
	Land Network	PSDN	DATA	

## Transmitting prepared message

This section explains routine telex transmission. For distress communication, see page 6-1.

For 2-digit code services and PSTN (FAX) communication, see page 4-17, respectively.

### common procedure for transmitting a message

1. Prepare message on the screen.
2. Press [F3] to display the Transmit menu.

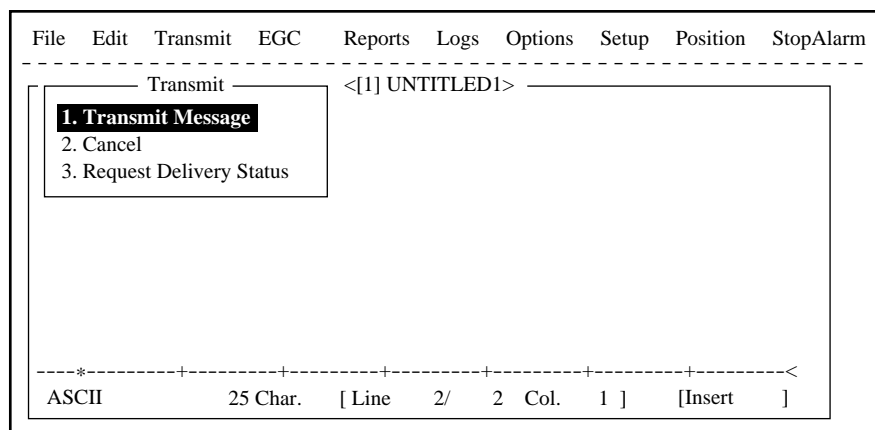

*Figure 4-1 Transmit menu*



- Press [Enter] or [1] to display the Transmit Message menu. The cursor is on the Priority line and “Normal” is selected.

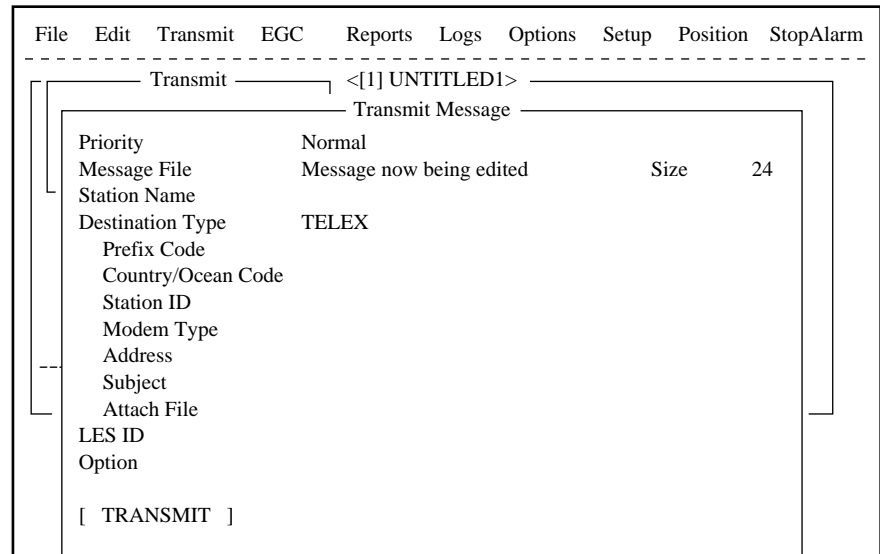

Figure 4-2 Transmit message menu

**Note:** An error message may appear under the conditions below:

*Unit is not logged-in. -Error message: Cannot start to send. (not logged-in)*

*Unit operates as an EGC-only receiver-Error Message: Cannot start to send. (EGC receiver)*

The message file line displays “Message now being edited” when a file is currently displayed.

- Press [ ↓ ] three times to place the cursor on the Destination Type line.
- Press [Enter] to open the selection window.
- Select Destination Type among “TELEX”, “FAX” or “SPEC (Prefixed)”.

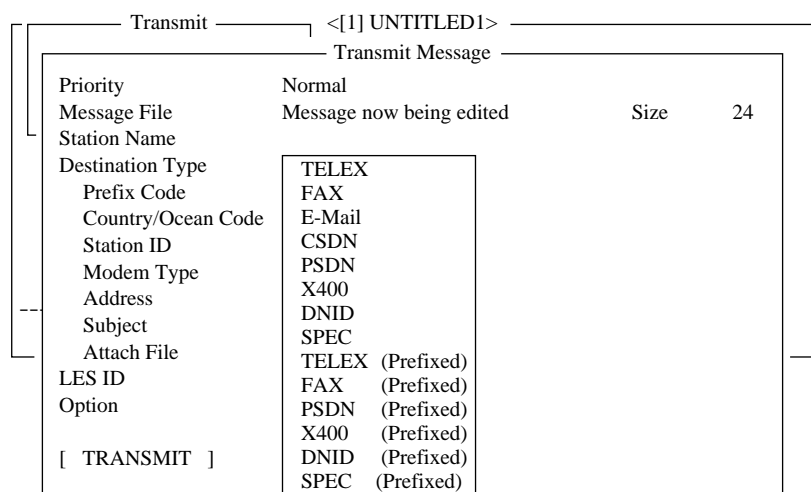

Figure 4-3 Transmit message menu, destination type window

- Press [Enter] to close selection window.

8. Follow instructions below for TELEX (Prefixed), or go to page 4-5 for FAX or E-Mail.

Destination type: TELEX (Prefixed)

- (1) Press [ ↓ ] to place the cursor on the Prefix Code line.
- (2) Press [Enter] to open the window for prefix code entry.
- (3) Key in prefix code in the digits.  
Note that some services may not be available depending on LES.

Prefix Code	Function
11	Operator's Assistance
12	Dial Guide
33	Technical Assistance
91	Automatic Telex Test
⋮	⋮

- (4) Press [Enter] to close the window.
- (5) Press [ ↓ ] to place the cursor on the Country/Ocean Code line.
- (6) Press [Enter] to open the window for country/ocean code entry.
- (7) Type either international telex country code of recipient (ship-to-shore) or ocean region (ship-to-ship). A list of international telex country codes begins on page A-1 in the Appendix.

Ocean Region

AOR-East: 581  
 POR: 582  
 IOR: 583  
 AOR-West: 584

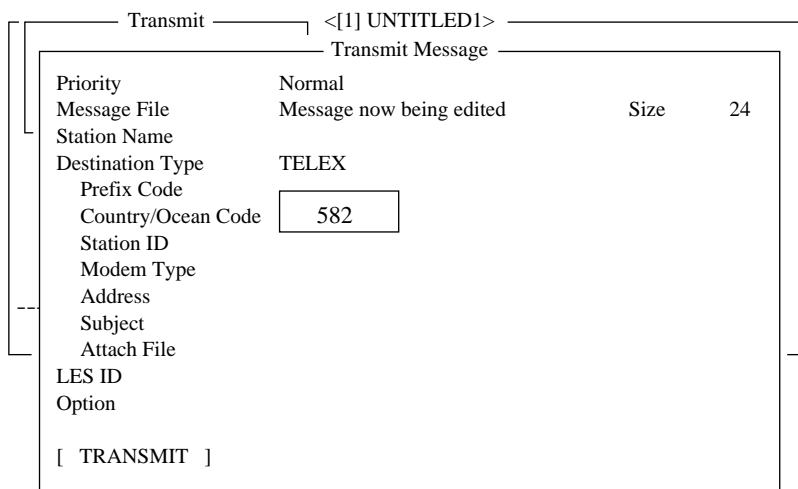

Figure 4-4 Transmit message menu, country/ocean code window

- (8) Press [Enter] to close the window.

- (9) Press [ ↓ ] to send the cursor to the Station ID line.
- (10) Press [Enter] to open the window for station ID entry.

```

Transmit <[1] UNTITLED1>
  Transmit Message
  Priority          Normal
  Message File     Message now being edited      Size  24
  Station Name
  Destination Type  TELEX
  Prefix Code
  Country/Ocean Code
  Station ID
  Modem Type
  Address
  Subject
  Attach File
  LES ID
  Option
  [ TRANSMIT ]

```

Figure 4-5 Transmit message menu, station ID window opened

- (11) Type either recipient's telex subscriber number (ship-to-shore) or receiving MES INM (ship-to-ship).
- (12) Press [Enter] to close the window.
- (13) Go to step 9 at the top of page 4-7.

Destination type: FAX

- (1) Press [ ↓ ] to advance the cursor to the Modem Type line.
- (2) Press [Enter] to open the selection window.

```

Transmit <[1] UNTITLED1>
  Transmit Message
  Priority          Normal
  Message File     Message now being edited      Size  24
  Station Name
  Destination Type  FAX
  Prefix Code
  Country/Ocean Code
  Station ID
  Modem Type
  Address
  Subject
  Attach File
  LES ID
  Option
  [ TRANSMIT ]

```

Modem Type	
T30	FAX
V21	V.21 300bps Duplex
V22	V.22 1200bps Duplex
V22B	V.22bis 2400bps Duplex
V23	V.23 600/1200bps
V26B	V.26bis 2400/1200bps
V26T	V.26ter 2400bps Duplex
V27T	V.27ter 4800/2400bps
V32	V.32 9600bps Duplex
Other	

Figure 4-6 Transmit message menu, modem type window opened

- (3) Select "T30".
- (4) Press [Enter] to close the selection window.
- (5) Go to step 9 at the top of page 4-7.

Destination type: E-mail

- (1) Press [ ↓ ] to advance the cursor to the Address line.

(2) Press [Enter] to open the window for address entry.

The screenshot shows a terminal window titled "<[1] UNTITLED1>". At the top, there is a "Transmit" label and a "Transmit Message" header. The main content is a list of fields for a message being transmitted:

Priority	Normal		
Message File	Message now being edited	Size	24
Station Name			
Destination Type	E-Mail		
Prefix Code			
Country/Ocean Code			
Station ID	INET		
Modem Type			
Address	<input type="text"/>		
Subject	<input type="text"/>		
Attach File	<input type="text"/>		
LES ID	201 (SANTA PAULA)		
Option			

At the bottom of the window, there is a "[ TRANSMIT ]" option.

Figure 4-7 Transmit message menu, address window

- (3) Type recipient's E-mail address.
- (4) Press [Enter] to close the window.
- (5) Press [ ↓ ] to advance the cursor to the Subject line.
- (6) Press [Enter] to open the window for subject entry.

This screenshot is identical to Figure 4-7, but the cursor is now positioned on the "Subject" line, and the "Subject" input field is active, indicating that the subject entry window is open.

Figure 4-8 Transmit message menu, subject window opened

- (7) Type subject.
- (8) Press [Enter] to close the window.
- (9) Press [ ↓ ] to advance the cursor to the Attach File line.
- (10) Press [Enter] to open the select File window.

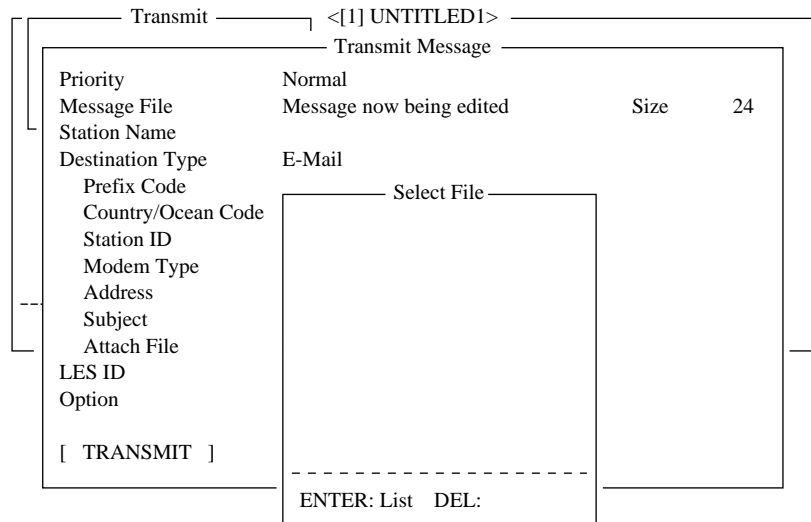

Figure 4-9 Transmit message menu, select file window opened

- (11) Press [Enter] to open the file list window.  
To change drive on a PC, move the cursor to the command line, type drive name (for example, "A"), and move the cursor to anywhere in the File Name column.
- (12) Press [Enter] to select file and close the file list window.
- (13) Press [Esc] to close the select file.  
Go to step 9 at the top of the next page.

**procedure for transmitting a message (con't from page 4-5 )**

9. Press [ ↓ ] to advance the cursor to the LES ID line.
10. Press [Enter] to open the selection window.

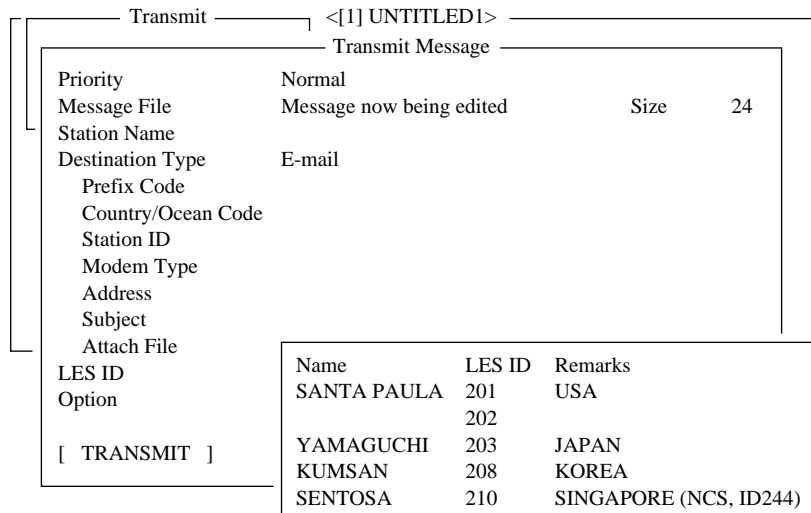

Figure 4-10 Transmit message menu, LES ID window opened

**Note:** If the LES ID entered is invalid, "Cannot use this LES. Please check network configuration." appears.

11. Select LES ID.
12. Press [Enter] to close the selection window.

13. Press [ ↓ ] to send the cursor to the Option line.

14. Press [Enter] to open the option window.

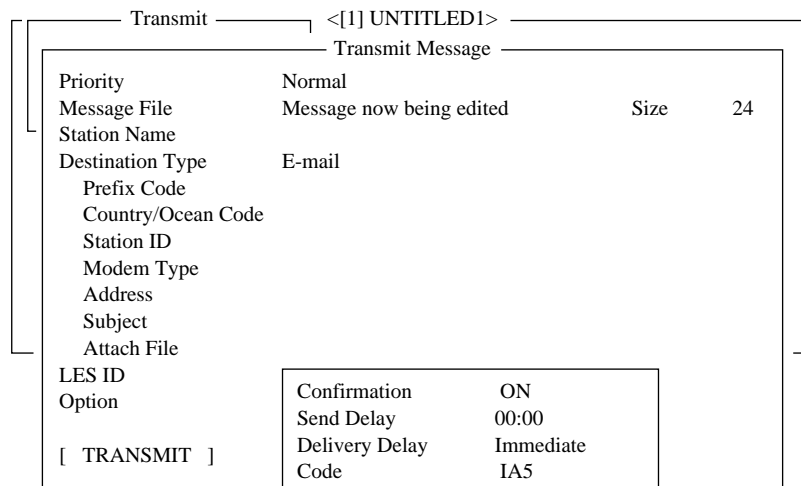

Figure 4-11 Transmit message menu, option window opened

15. Press [Enter] to open the selection window.

16. To receive confirmation from the LES when message has been delivered to recipient, select ON. If not required, select OFF.

17. Press [Enter] to close the selection window.

18. Press [ ↓ ] to send the cursor to the Send Delay line.

19. Press [Enter] to open the window for send delay entry.

20. To send a message after a certain delay enter a time up to 99 hours 59 minutes.  
(The Send Delay is used to time message arrival to suit recipient's office hours.)

21. Press [Enter] to close the window.

22. Press [ ↓ ] to go to the Delivery Delay line.

23. Press [Enter] to open the selection window.

24. The Delivery Delay line requests the LES for "Immediate" or "Deferred" transmission to the recipient designated. Select either immediate or deferred. For information on this service, consult with LES to which message is to be sent.

25. Press [Enter] to close the selection window.

26. Press [ ↓ ] to send the cursor to the Code line.

27. Select "IA5", "ITA2" or "DATA".  
Normally, IA5.

28. Press [Enter] to close the selection window.

29. Press [Esc] to close the option window.

30. Press [ ↓ ] to place the cursor on TRANSMIT.

31. Press [Enter] to open the start window.
32. Press [Enter] to transmit the message to the message buffer. (To escape, select No and press [Enter].) The message “Message is entered in sending Buffer.” appears and the message prepared is printed.

**Note:** *The message buffer can only hold one message. However a second message may be sent to the buffer by assigning a Send Delay to it.*

*When the message buffer is full, “Cannot enter this message to sending Buffer.” appears to alert you.*

33. Press any key to return to the standby display.

The message(s) will be transmitted according to Send Delay setting. “Current State: SENDING” appears at the bottom of the screen during transmission.

If the message was transmitted successfully “Successful Sending message” appears and its particulars are sent to the Display Log.

### **TRANSMIT MESSAGE STATUS**

*The terminal unit displays transmit message status as follows:*

*“Message Send failed.” This appears if the message could not be transmitted because of technical reasons such as satellite malfunction, signal degradation, or no reply from LES. Try to transmit the message again.*

*“Message Send rejected.” This appears when the LES rejects the message because of non-technical reasons such as unpaid subscriber’s fee.*

*“Message Send pending.” This appears when the circuits at the LES are busy. Your message will be transmitted when a circuit becomes clear.*

### **Transmitting message stored on floppy disk (multiple address)**

1. Close any open files.
2. Insert floppy disk containing file to be sent. (Be sure to insert the floppy disk completely in the drive. Otherwise, “FD not inserted in drive.” appears.)
3. Press [F3] to display the Transmit menu.

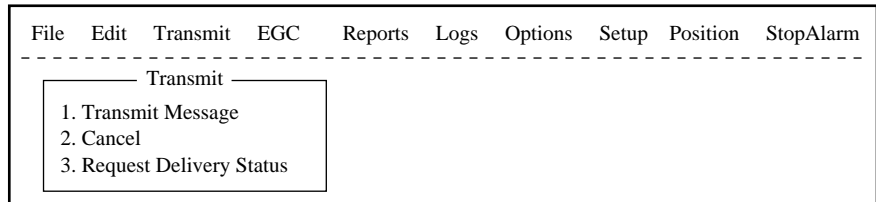

Figure 4-12 Transmit menu

4. Press [1] to select Transmit Message.

The cursor is on the Priority line and “Normal” is selected.

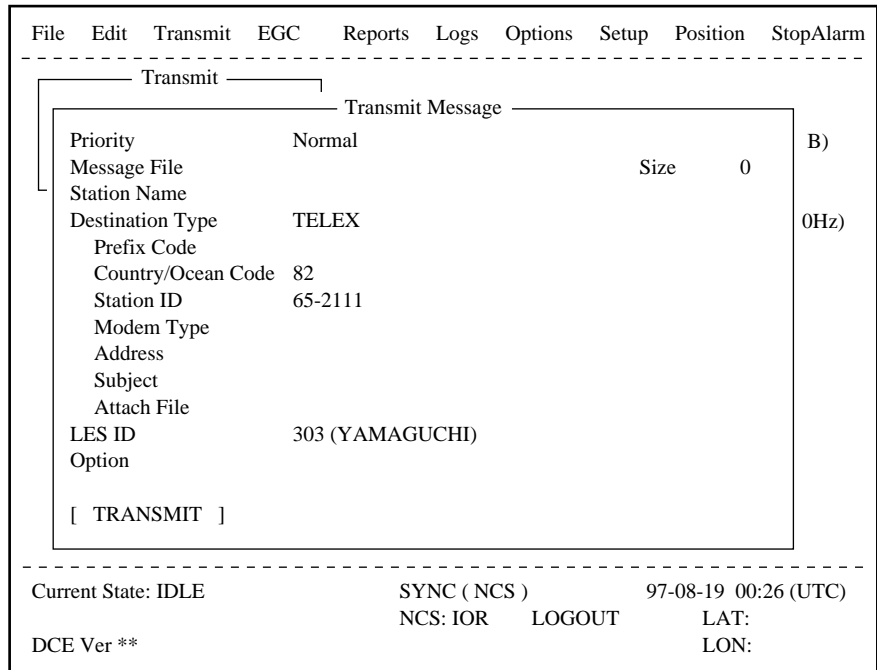

Figure 4-13 Transmit message menu

5. Press [ ↓ ] to advance the cursor to the Message File line.

6. Enter the file name manually, or select it from the message file list of the floppy disk as follows.

a) Press [Enter] to display Message File list.

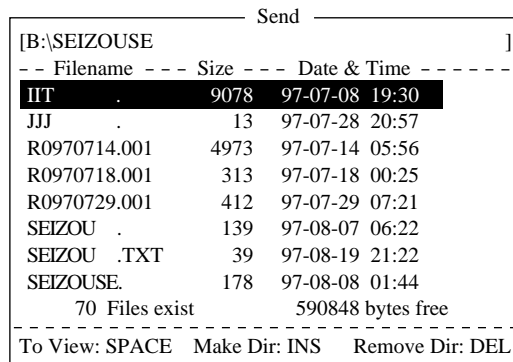

Figure 4-14 File list



- b) Select a file.
  - c) Tap the space bar to display a portion of the file in the view window. Press the [Esc] key.
  - d) Press [Enter]. The Message File screen appears with the file selected.
7. Press [ ↓ ] to advance the cursor to the Station Name line.
  8. Press [Enter] to open the Station List.

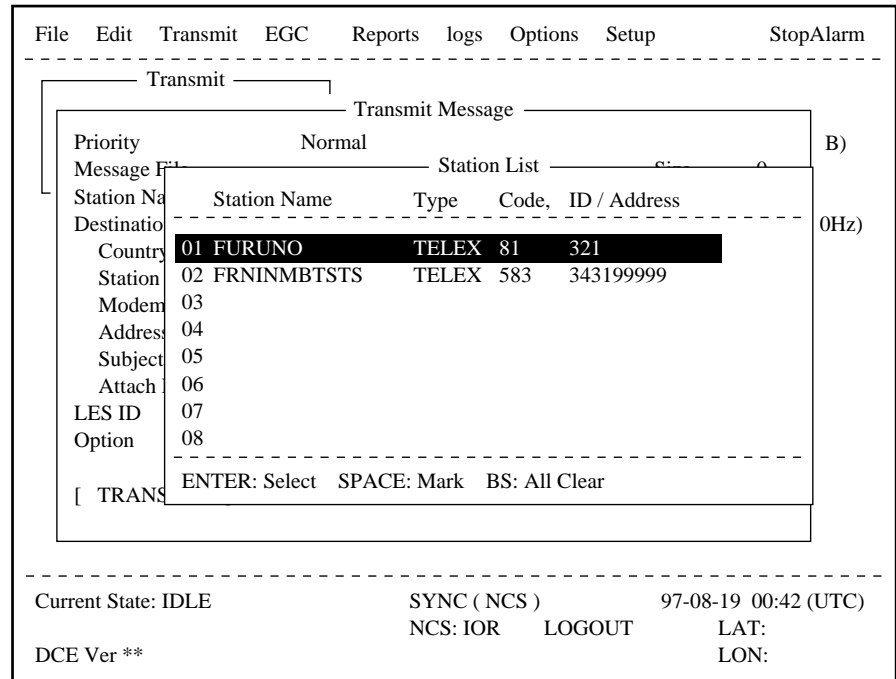

Figure 4-15 Select station screen

9. Select station and press [Enter].  
To select more than one station, press [Space] bar after selecting station. An asterisk appears next to station(s) selected.  
For E-mail, you can select T (TO:Address) or C (CC:Carbon copy) by pressing [Space] bar.

**Note :** Different types or prefix code of messages cannot be transmitted simultaneously.

Station List			
Station Name	Type	Code, ID / Address	
01 FURUNO	TELEX	81	321
02 FRNINMBTSTS	TELEX	583	343199999
*03 Seagull	E-mail	Seagull@furuno.co.jp	
*04 whale	E-Mail	whale@furuno.co.jp	
05			
06			
07			
08			
ENTER: Select SPACE: Mark BS: All Clear			

Figure 4-16 With asterisk mark

10. Press [ ↓ ] key to advance the cursor to the LES ID line.
11. Press [Enter] to open the LES Table.



**Note:** If a file name which was entered manually does not exist when you attempt to transmit the file at step 13. "Input Error: Message File" appears. Press any key to erase the error message then enter correct name.

## Canceling transmission

As noted earlier a transmit message is held in the buffer, usually until it is transmitted satisfactorily. To cancel transmission on a message held in the buffer, do the following:

1. Press [F3] to display the Transmit menu.
2. Press [2] to display the Cancel screen.

File	Edit	Transmit	EGC	Reports	Logs	Options	Setup	Position	StopAlarm
-----									
Transmit			<[1] UNTITLED1>						
1. Transmit Message 2. Cancel									
-----									
			Cancel						
No.	Message File	Station	LES	Priority	Send Status	Delivery			
01	edit_msg.001		SANTA PAUL	Normal	Waiting				
-----									
ASCII		25 Char.	[ Line	2/ 2	Col.	1 ]	[Insert	< ]	
-----									
Current State: IDLE			SYNC ( NCS )			97-08-08 07:37 (UTC)			
			NCS: POR			LOGIN			
DCE Ver **									

*Figure 4-20 Sample cancel screen*

### Send status

- Waiting:** Waiting to transmit message.
- Sending:** Now sending message.
- Fail:** Failed transmission
- Rejected:** Message rejected by LES.
- Pending:** LES circuits occupied.

3. Select message you want to cancel.

4. Press [Enter] to open the Cancel window.

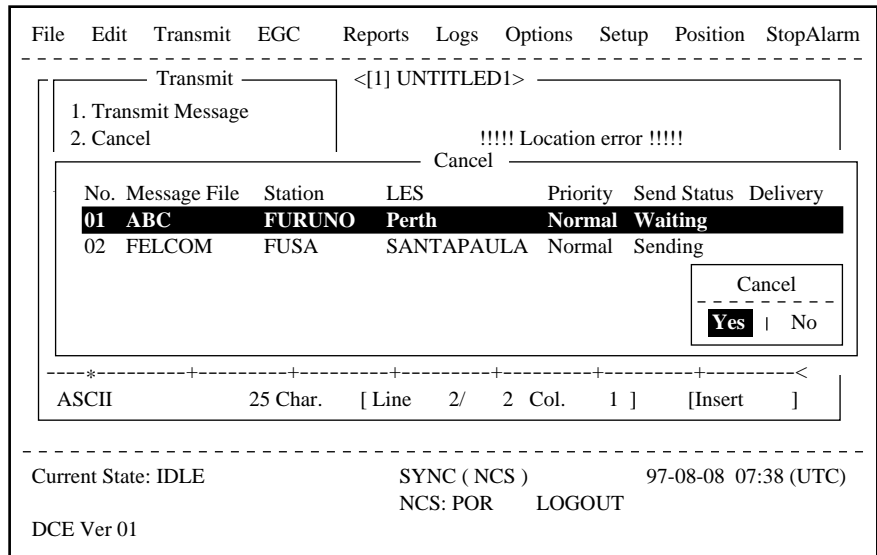

Figure 4-21 Cancel window

5. Press [Enter] to cancel a message from transmission, or select “No” and press [Enter] to escape from the Cancel menu.

6. Press [Esc] to return to the default display.

### Confirming delivery status (message status list)

You can automatically receive delivery status of messages you send to a LES, by selecting “Confirming ON” in the Send Message menu. (Delivery Status can also be confirmed manually. See page 4-16.) Messages transmitted which request delivery status appears in the Message Status List.

The Message Status List holds delivery status information for 30 messages. When the list is full, the oldest entry is deleted to make room for the latest.

1. Press [F3].

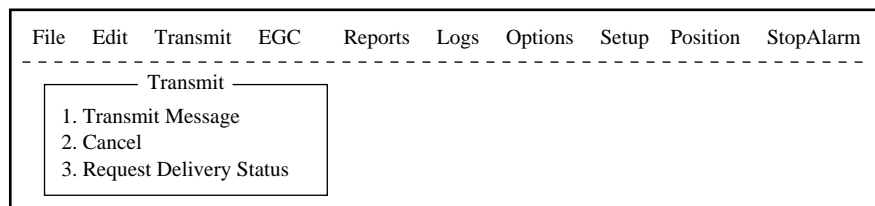

Figure 4-22 Transmit menu

2. Press [3] to display the Request Delivery Status menu.

Request Delivery Status						
No.	Message File	Station	LES	Priority	Send Status	Delivery
01	ABC	FURUNO	Yamaguchi	Normal	Waiting	
02	DEF	FURUNO	Yamaguchi	Normal	Sending	
03	GHI	ASDFASDF	202	Normal	97-03-20	9:40 OCC(002)
04	JKL		303	Normal	97-03-18	20:16
05	MNO	ABCDEFGHIJ	123	Normal	97-03-18	16:09 Complete
06	edit msg.002		202	Normal	97-03-18	9:48 EEE(001)
07	edit msg.001		Yamaguchi	Normal	97-03-16	12:34 ?????

*Figure 4-23 Sample request delivery states*

### Message status list description

- No.:** Message number
- Message File:** File name. For no file name, “edit msg. 00X” appears (X = number from 001-999).
- Station:** Name of remote party (recipient)
- LES:** The LES which received the message.
- Priority:** Normal or distress
- Send Status:** The transmission status from the MES (own ship) to the LES; waiting or sending, and data and time of transmission for messages transmitted.
- Delivery:** The delivery status from the LES to the recipient.  
 Complete: Message transmitted successfully  
 White space: Delivery status not yet received  
 Reason for no delivery:

- OCC(002): Delivery tried (twice), but recipient busy.
- ABS: Absent subscriber
- BK: Message aborted
- BMC: No end of message or end of transmission received
- DER: Out of Order
- DTE: Remote DTE clearing
- EOS: Element of Service not subscribed (E-mail)
- FMT: Format error
- IAB: Invalid answerback
- INC: Inconsistent Request (E-mail)
- INF: Call the Network Information service
- INV: Invalid Call
- ITD: Awaiting delivery
- LDE: Maximum message length exceeded
- LPE: Local Procedure Error
- NA: Access Barred
- NC: Network Congestion
- NCH: Subscriber’s number has been changed
- NP: Not Obtainable
- NRC: Reverse charging acceptance not subscribed
- RIS: Recipient Improperly Specified (E-mail)
- RDI: Redirected call
- RPE: Remote Procedure Error

- RSB: Retransmission still being attempted
- TMD: Maximum number of addresses exceeded
- UNK: Unknown status (for example when the Logical channel number is zero)

**Note:** Some LES do not use certain codes.

## Manually requesting delivery status

You can request a LES for delivery status of a message you have transmitted there within the past 24 hours.

1. Press [F3].
2. Press [3] to display the Request Delivery Status display.

Request Delivery Status						
No.	Message File	Station	LES	Priority	Send Status	Delivery
01	ABC	FURUNO	Perth	Normal	97-11-06 16:10	
02	edit msg.002	FURUNO	Perth	Normal		

*Figure 4-24 Request delivery status display*

3. Select a file.
4. Press [Enter]. A prompt asks you if you want to request delivery status on that message.

Request Delivery Status						
No.	Message File	Station	LES	Priority	Send Status	Delivery
01	ABC	FURUNO	Perth	Normal	97-11-06 16:10	
02	edit msg.002	FURUNO	Perth	Normal		

Start
-----
<b>Yes</b>   No

*Figure 4-25 Sample message file list*

5. Press [Enter] to request status. “Request started” appears on the display. (To cancel request, select “No” and press [Enter].)
6. “Press any key.” appears on the display; press any key to return to the standby display.

Several minutes later the reply from the LES appears in the Delivery column of the Request Delivery Status screen.

## The 2-digit code services

A range of special safety and general maritime services, known as the 2-digit code services, may be received. The list on the next page shows the 2-digit code services available.

To access a 2-digit code service;

1. Using the text editor, prepare message requesting a 2-digit code service. (Refer to next page.)
2. Press [F3] to display the Transmit menu.
3. Press [Enter] to display the Transmit Message.

The screenshot shows a menu titled "Transmit" with a sub-menu "Transmit Message". The menu items are:

- Priority: Normal
- Message File: Message now being edited
- Size: 24
- Station Name
- Destination Type: TELEX
- Prefix Code
- Country/Ocean Code
- Station ID
- Modem Type
- Address
- Subject
- Attach File
- LES ID
- Option

At the bottom of the menu is the option [ TRANSMIT ].

*Figure 4-26 Transmit message menu*

4. Press [ ↓ ] three times to place the cursor on the Destination Type line.
5. Press [Enter] to open the selection window.
6. Select "SPEC" (Special).
7. Press [Enter] to close the selection window.
8. Press [ ↓ ] to place the cursor on the Station ID line.
9. Press [Enter] to open the window for station ID entry.
10. Key in 2-digit code referring to the tables on the next page.
11. Press [Enter] to close the window.

### For maritime safety service;

32	Medical advice	Used for requesting medical advice.
38	Medical assistance	Used for requesting medical assistance.
39	Maritime assistance	Used for requesting maritime search and rescue assistance.
41	Meteorological reports	Necessary for ease of addressing weather reports from ships to meteorological centers.
42	Navigational Hazards and warnings	Used for making urgent navigational meteorological danger reports.
43	Ship position reports	Used for routing of messages to ship safety reporting systems.

### For general utility;

31	Maritime enquiries	Desirable for requesting information including service offerings.
33	Technical assistance	Desirable for addressing technical enquiries to appropriate personnel.
37	Time and charges requested at end of call	Desirable for mobile operator when sending traffic for a third party.

12. Press [ ↓ ] to advance the cursor to the LES ID line.
13. Press [Enter] to open the LES table.
14. Press [Enter] to select LES ID.
15. Press [ ↓ ] to place the cursor on TRANSMIT.
16. Press [Enter]. A prompt asks if it is alright to start transmission. (The Confirmation, Send Delay and Delivery Delay remain “ON”, “00:00” and “Immediate”, respectively. If necessary, change these settings before pressing [Enter].)
17. Press [Enter] to transmit the message prepared.
18. Press any key to return to the standby display.

The message will be transmitted according to Send Delay setting. “Current State: SENDING” appears at the bottom of the screen during transmission.

If the message was transmitted successfully “Successful Sending message” appears and its particulars are sent to the Display Log.

**Note 1:** *At present, not all LESs are offering the 2-digit code services. To find out which LESs are offering the services, contact the LES Operations Coordinator directly.*

**Note 2:** *Some 2-digit code services may be provided free of charge by LESs, while other services are chargeable, in some cases at reduced rates. For information, contact the LES directly.*



## Inserting the destinations of a fax terminal

You can send a text message to a Group 3 type fax terminal which is connected to the international PSTN (telephone) land line, provided the LES selected supports fax delivery.

1. Prepare message. (To send stored file, close any open files.)
2. Press [F3] to display the Transmit menu.
3. Press [1] to select Transmit Message.  
The cursor is on the Priority line and “Normal” is selected.
4. Press [ ↓ ] to advance the cursor to the Message file line.
5. The message file line displays “Message now begin edited.” when a file is the currently displayed. To send a file stored on a floppy disk, select the file from the file list.
6. Press [ ↓ ] to advance the cursor to the Destination Type line.
7. Press [Enter] to open the selection window.
8. Select “FAX”.
9. Press [Enter] to close the selection window.

Transmit Message			
Priority	Normal		
Message File	Message now being edited	Size	77
Station Name			
Destination Type	FAX		
Prefix Code			
Country/Ocean Code			
Station ID			
Modem Type			
Address			
Subject			
Attach File			
LES ID			
Option			
[ TRANSMIT ]			

*Figure 4-27 Transmit message menu, FAX selected*

10. Press [ ↓ ] to advance the cursor. The cursor is now on the Country/Ocean Code line.
11. Press [Enter] to open the window for country/ocean code entry.
12. Key in international telephone code of recipient. A list of international telex/telephone country codes begins on page A-1 in the Appendix.
13. Press [Enter] to close the window.
14. Press [ ↓ ] to send the cursor to the Station ID line.
15. Press [Enter] to open the window for station ID entry.
16. Enter facsimile number.

17. Press [Enter] to close the window.
18. Press [ ↓ ] to send the cursor to the Modem Type line.
19. Press [Enter] to display the list of modem types.
20. Press [Enter] to select “T30”. (Other modem types are not supported.)
21. Press [ ↓ ] to advance the cursor to the LES ID line.
22. Press [Enter] to open the LES Table.
23. Select LES ID.

**Note:** *If the LES ID entered is invalid, “Cannot use this LES. Please check network configuration.” appears.*

24. Press [Enter] to close the LES Table.
25. Press [ ↓ ] twice to place the cursor on TRANSMIT.
26. Press [Enter] twice to send the message to the message buffer. (To escape, select No and press [Enter].) The message “Message is entered in sending Buffer.” appears. At the same time, the message prepared is printed.
27. Press any key to return to the standby display.

The message(s) will be transmitted according to the Send Delay setting. “Current State: SENDING” appears at the bottom of the screen during transmission.

When the message is transmitted successfully “Successful Sending message” appears and its particulars are sent to the Display Log.

## Receiving

### When a message is received

Each time the FELCOM 12 receives a message it automatically registers, saves, prints (except messages with passwords) and files it.

#### 1) received alarm

When a message is received, the audible alarm sounds. Silence the audible alarm by pressing the [F10] key on the keyboard.

#### 2) registration

Each message received is assigned a receive message number. This number is also used when the file is saved to a floppy disk.

<u>R</u>	<u>0</u>	<u>9</u>	<u>7</u>	<u>0</u>	<u>1</u>	<u>1</u>	<u>5</u>	<u>0</u>	<u>0</u>	<u>1</u>
Receive	0: main DTE	year	month	day	receive	message no.				
	1: 2nd DTE									

### 3) display log

The Display Log shows message number, priority, date and time of transmission, LES ID and file size (in bytes) of the latest 50 received and transmitted messages.

### 4) printing

Printing of a message begins (except messages with passwords) as soon as it is received.

### 5) saving and filing

The DTE saves and files a receive message to the Display Message List. (For installations with both a main and a 2nd DTE, you may select where to store receive messages, on the system setup menu.) The Display Message List shows the following:

Receive message no.  
LES ID  
Priority  
File size (in bytes)  
Message classification  
Password for confidential messages  
Date and time of transmission  
Status

## Setting the receive alarm

An audible alarm may be set to ring when a routine message is received. The factory setting is OFF.

1. Press [F8] to display the Setup menu.
2. Press [6] to display the Auto Mode Setup.

Setup	
Auto Mode Setup	
Auto Log Print	OFF
Receive Alarm	ON
Auto Telex Msg Save	ON
Auto EGC Msg Save	OFF
Data Report & Polling Print	ON
7. E-Mail Setup	
8. Directories	
9. Configuration	

Figure 4-28 Auto mode setup menu

3. Press [ ↓ ] to send the cursor to the Receive Alarm line.
4. Press [Enter] to open the selection window.
5. To enable the alarm, select ON. The alarm will be released for one second when a message is received.

6. Press [Enter] to close the selection window.
7. Press [Esc] twice.

## Displaying receive messages

When you can't read an attached file in Log menu refer to page 3-15.

1. Press [F6].
2. Press [2] to display list of receive messages.

Message No.	LES	Priority	Size	Addressee	Rec date & Time	Status
<b>R0971106.001</b>	<b>Perth</b>	<b>Normal</b>	<b>32767</b>		<b>97-11-06 16:10</b>	<b>Saved</b>
R0971105.002	ABCDEFGHIJ	Normal	200	CAPTAIN	97-11-05 17:30	
R0971105.001	Perth	Distress	1234		97-11-05 14:15	Printed
R0971024.001	Perth	Normal	8251		97-10-24 13:20	Saved

Space: display part view

Memory Available: 12345 Bytes

(Part View Window)

Figure 4-29 Sample display message screen

### Display message list description

- Message No.:** Receive message no.
- LES:** LES name
- Priority:** Normal or distress
- Size:** Size of file in bytes
- Addressee:** Addressee code appears for confidential messages. Nothing appears for routine messages.
- Rec date & time:** Date and time message was received.
- Status:**  
 Printed: message printed  
 Saved: message saved to floppy disk  
 No display: not yet printed confidential message, or printer malfunction
- Memory available:** Memory available in DTE

3. Select a file. To get a partial display of a file selected, tap the space bar. A part of the file appears in the View Window.

- Press [Enter] for routine messages and messages with addressee code (no password).  
Your selection appears on the display.

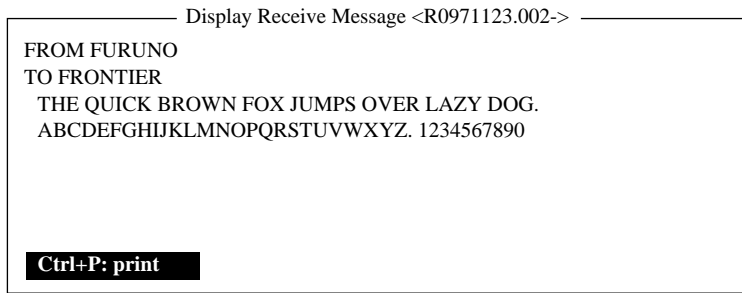

Figure 4-30 Sample receive message

- For messages with both addressee code and password, a Password window appears. Enter the password corresponding to the addressee code and then press [Enter]. If the password is entered incorrectly an alarm sounds. Reenter the password.

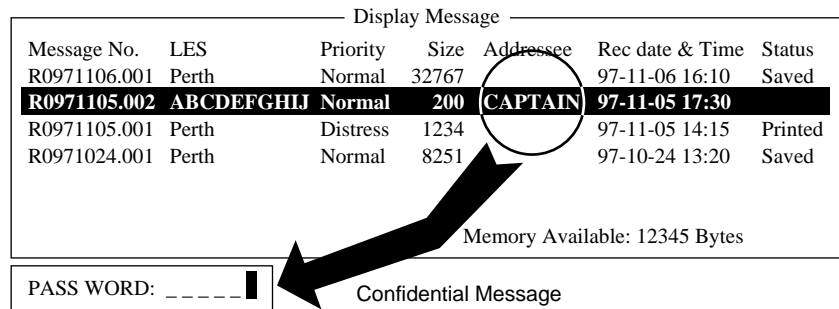

Figure 4-31 Location of password

The screen can be scrolled with the up and down arrow keys.

## Printing receive messages

- Follow steps 1 thru 6 in “Displaying receive messages”.
- While pressing and holding down [Ctrl], press [P]. The printer starts printing the message on the screen.

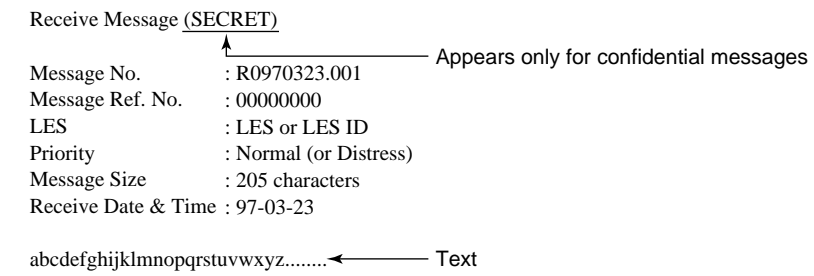

Figure 4-32 Sample receive message printout

## Saving receive messages to a floppy disk

1. Press [F6].
2. Press [2] to display the Receive Message Log.

Receive Message Log						
Message No.	LES	Priority	Size	Addressee	Rec date & Time	Status
<b>R0971106.001</b>	<b>Perth</b>	<b>Normal</b>	<b>32767</b>		<b>97-11-06 16:10</b>	<b>Saved</b>
R0971105.002	ABCDEFGHJ	Normal	200	CAPTAIN	97-11-05 17:30	Printed
R0971105.001	Perth	Distress	1234		97-11-05 14:15	Printed
R0971101.001	Perth	Normal	3256	OFFICER	97-11-01 3:45	Printed
R0971024.001	Perth	Normal	8251		97-10-24 13:20	Saved

Memory Available: 3317 Bytes

---

Enter: Display   S: Save   D: Delete

Figure 4-33 Sample delete message screen

3. Select a file. Press the [Enter] key to confirm contents of file. After confirming contents, press the [Esc] key.
4. For confidential messages enter password. This password will also be saved to the floppy disk.
5. Press the [S] key to save the file to the floppy disk.

**Note:** *If a file by that name already exists on the floppy disk, "A file by that name already exists on FD." appears.*

## Automatically saving receive messages

1. Press [F8].
2. Press [6] to display Auto Mode Setup menu.

Setup	
Auto Mode Setup	
<b>Auto Log Print</b>	OFF
Receive Alarm	ON
Auto Telex Msg Save	ON
Auto EGC Msg Save	OFF
Data Report & Polling Print	ON

7. E-Mail Setup  
8. Directories  
9. Configuration

Figure 4-34 Auto mode setup menu

3. Press [↓] to select "Auto Telex MSG Save".
4. Press [Enter] to open the selection window.
5. Select "ON".
6. Press [Enter] to close the selection window.
7. Press [Esc] twice.

The drive and directory where to save receive messages and created files can be specified with “MSG Directory”. The default setting is as follows;

For IB-581 B:\  
 For PC “MAIL” directory in directory which stores program files

**Note:** For IB-581 do not specify the ROM disk (drive A) as the “MSG directory.” The ROM disk can only be written to 1000 times.

Receive messages are automatically assigned a file name as described on page 4-20.

EGC messages can also be automatically saved. EGC messages are automatically assigned a file name and they begin with E.

### Deleting receive messages

1. Press [F6].
2. Press [2] to display list of receive messages.

Delete Message						
Message No.	LES	Priority	Size	Addressee	Rec date & Time	Status
<b>R0971106.001</b>	<b>Perth</b>	<b>Normal</b>	<b>32767</b>		<b>97-11-06 16:10</b>	<b>Saved</b>
R0971105.002	ABCDEFGHIJ	Normal	200	CAPTAIN	97-11-05 17:30	Printed
R0971105.001	Perth	Distress	1234		97-11-05 14:15	Printed
R0971101.001	Perth	Normal	3256	OFFICER	97-11-01 3:45	Printed
R0971024.001	Perth	Normal	8251		97-10-24 13:20	Saved

Memory Available: 3317 Bytes

(Part View Window)

Figure 4-35 Sample delete message screen

3. Select the message you want to delete. To display a part of a message (except confidential messages), tap the space bar.
4. To view a portion of a confidential file, enter the password and then tap the space bar.
5. Press [D]. You are asked to confirm.
6. Press [Enter] to delete the message, or select No and press [Enter] to escape.
7. To return to the standby display, press [Esc] three times.

## Distress/Urgent Receiving Call Unit IC-303

The IC-303 releases an audio alarm when a distress or urgency priority EGC message is received. Press the ALARM RESET button to acknowledge the alarm, and the tone of alarm changes. To silence the alarm, press the [F10] key on the keyboard of terminal unit.

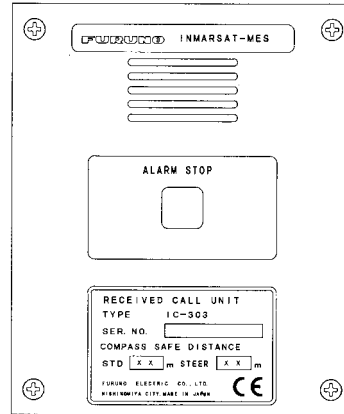

Figure 4-36 Distress/Urgent Receiving Call Unit IC-303

## Display Log

The Display Log stores the particulars of the latest 50 received and transmitted messages. When the log is full, the oldest message is deleted.

### Displaying and printing the display log

1. Press [F6].
2. Press [4] to display the Display Log.

S/R	Message No.	Type	Pri	Date	Time	LES	Station	Size	Cond
01	S T0971110.001	TELEX	Nrm	97-11-10	19:10	302	FURUNO	12345	Success
02	R R0971110.001	TELEX	Dis	97-11-10	19:25	302	-----	365	-
		PSTN							Fail
		PSDN							
		E-mail							
		(etc.)							
:									
50	(max)								

**Ctrl+P: print**

Figure 4-37 Sample display log

3. To scroll the Display Log screen, press the down key several times.
4. To print the log, press and hold down [Ctrl] and press [P]. "Now printing" appears on the screen.



## display log description

<b>S/R:</b>	Send or Receive message
<b>Message No.:</b>	Message no. or file name
<b>Type:</b>	Currently, TELEX, PSTN, PSDN or SPEC (2-digit code service).
<b>Pri:</b>	Normal or distress
<b>Date:</b>	Date message was received (or transmitted).
<b>Time:</b>	Time message was received (or transmitted).
<b>LES:</b>	ID of LES which handled the message
<b>Station:</b>	Transmitting station name. Blank for unregistered station or receive message.
<b>Size:</b>	Size of message in bytes
<b>Cond:</b>	Transmission results. Blank if receive message.
<b>Success:</b>	Successful transmission
<b>Fail:</b>	Failed transmission
<b>Rejected:</b>	Message rejected by LES

## Automatic printing of display log

The Display Log can be automatically printed every 24 hours.

1. Press [F8] to display the Setup menu.
2. Press [6] to display the Auto Mode Setup menu.

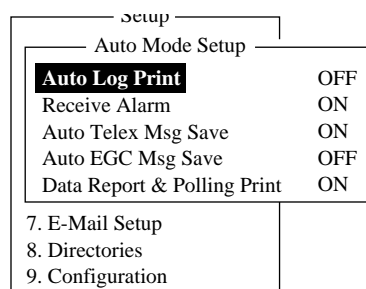

*Figure 4-38 Auto mode setup menu*

3. Press [Enter] to open the selection window of Auto Log Print.
4. Set Auto Log Print to ON.
5. Press [Enter] to close the selection window.
6. Press [Esc] twice.

## Display send message log or receive message log

You can display send message log or receive message log as follow.

1. Press [F6].
2. Press [1] (Send message log) or [2] (Receive message log).
3. Press [Esc] to escape.

## EGC Messages

EGC messages are automatically received, printed and saved to the DTE. The memory capacity for EGC message is 32k bytes. When the memory is full, the oldest information is deleted.

### Displaying and reprinting EGC messages

1. Press [F6].
2. Press [3]. The Display EGC Message screen appears.

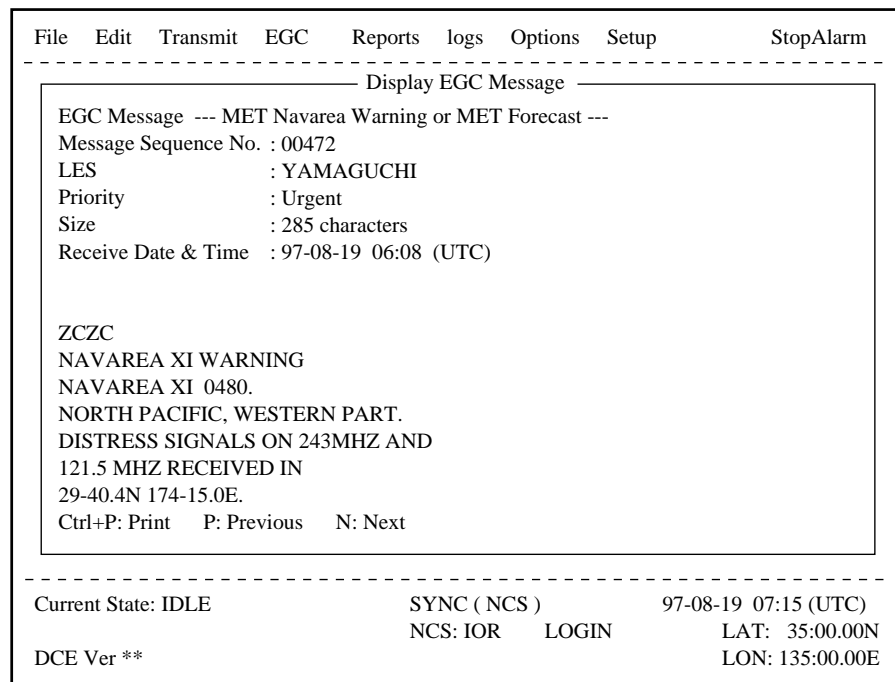

*Figure 4-39 Sample Display EGC Message screen*

3. To scroll the message, use the up and down arrow keys.
4. To view next and previous messages, use the [N] and [P] keys.
5. To print the message appearing on the display, press and hold down [Ctrl] and press [P]. To stop printing, press [Esc].

EGC messages can be automatically saved on a floppy disk. See page 4-24 for details.

## Displaying EGC closed network ID (ENID)

To join a FleetNET™ service, an MES must be registered with an information provider. The information provider adds the MES to the group which is to receive the service by downloading a Group Call ID, via a LES which supports FleetNET™ broadcasts, uniquely addressed to the MES. The MES stores the ID and can accept broadcasts from the information provider. The MES operator can not change this stored EGC closed network IDs (ENIDs). Up to 64 ENIDs are stored on a non-volatile memory.

The ENID stored can be accessed for downloading and deleting via the satellite path. It is possible for an MES operator to inhibit (or activate as required), via the DTE, selected ENIDs previously downloaded.

Along with the ENID, the name of the information provider is stored. In the event that a download command is received and the ENID storage area is full, then an ENID which has been inhibited (de-activated) by the MES operator will be written over. If none has been inhibited, then the new download is not accepted.

Follow the procedure below to inhibit (or activate) an ENID.

1. Press [F4] to display EGC menu.
2. Press [2] to display the EGC Network ID List.

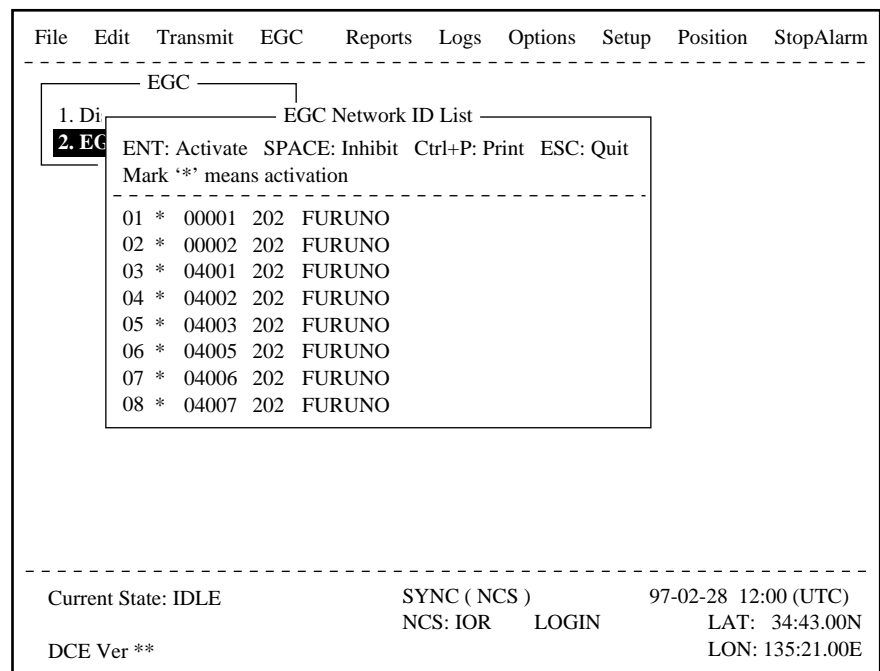

Figure 4-40 EGC network ID list

3. Select an ENID you want inhibit (or activate).
4. Press the Space bar to inhibit (or [Enter] key to reactivate).
5. Press [Esc] to return to the standby display.

## Receiving EGC distress or urgent message

When the FELCOM 12 receives a EGC distress or an urgent message, an alarm buzzer sounds on the terminal unit and the Distress/Urgent Receiving Unit IC-303 or the Distress Message Controller DMC-5 when connected.

To silence the alarm buzzer, press [F10] on the terminal unit.

**Note:** *To silence the alarm from the IC-302, also press [F10]. DO NOT press the DISTRESS button on the IC-302 to silence the alarm; you will transmit own ship's distress alert.*

## Tx Message Example Printout

The Tx message printout changes according to whether "Confirmation" (keying sequence: [F3], [1], "Option") on the transmit message is ON or OFF.

### Confirmation "OFF"

A TX message is printed when the message result is "Success".

---

```

Sent Message
DELIVERY CONFIRMATION OFF

Message File   : 00FOX.TXT           Message Size  : 277 characters
LES           : GOONHILLY          Date          : 99-03-10
Priority       : Normal             Time          : 06:06 (UTC)
Destination   : TELEX (Prefixed) 00111222222222222222 (IA5)
                                           00111333333333333333
                                           00111444444444444444

```

---

*Figure 4-41 TX message printout when Confirmation is OFF*

## Confirmation "ON"

The message "Delivery Status received for (file name)" is displayed when you received message delivery data and the message is printed.

*Note: After the message "Delivery Status received for" appears, wait more than two minutes before sending another message. If you attempt to transmit before two minutes has elapsed the the message and delivery information will be printed again.*

---

Sent Message  
DELIVERY CONFIRMED

Message File	: 00FOX.TXT	Message Size	: 277 characters
LES	: GOONHILLY	Date	: 99-03-10
Priority	: Normal	Time	: 06:06 (UTC)
Destination	: TELEX (Prefixed) 00111222222222222222 (IA5)		

---

*Figure 4-42 Tx message printout when Confirmation is ON (delivery confirmed)*

---

Sent Message but not delivered  
DELIVERY FAILURE : xxx (xxx = reason for no delivery)  
DELIVERY STATUS NOT RECEIVED (in case of timeout)

Message File	: 00FOX.TXT	Message Size	: 277 characters
LES	: GOONHILLY	Date	: 99-03-10
Priority	: Normal	Time	: 06:06 (UTC)
Destination	: TELEX (Prefixed) 00111222222222222222 (IA5)		

---

*Figure 4-43 Tx message printout when Confirmation is ON (message not delivered)*

*(This page intentionally left blank.)*

# DATA REPORTING AND POLLING

This chapter explains data reporting settings and polling reception. Data reporting provides automatic data transmission at regular intervals from your ship to your home office, when your ship receives a polling command from your home office, it automatically transmits data to your home office.

No operator intervention is required during polling reception.

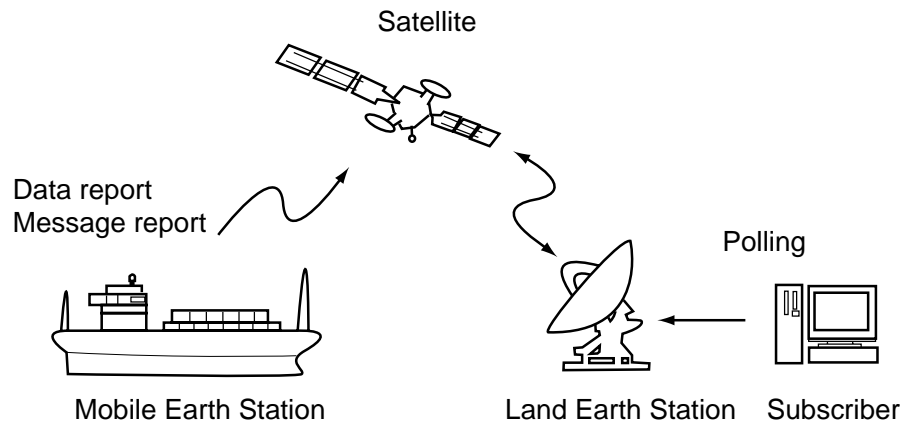

## Data Reporting

Data reporting provides automatic data transmission at regular (pre-set) intervals from your ship to your home office. The data are position, speed, bearing and other data sent from a navigational equipment or an interface unit.

The data transmitted from the FELCOM 12 is temporarily stored in a data reporting file at the LES. When an operator at your home office accesses the LES, the LES delivers the data to your home office. Some LESs may deliver it without being accessed.

Data reporting can be initiated by setting a data report on the FELCOM 12 or receiving a polling command from your home office.

FELCOM 12 offers two types of data reporting as follows:

- Data report ----- on MES signalling channel  
Refer to "Setting a data report" below.
- Message report --- on MES message channel  
Refer to "Setting a message report" on page 5-4.

## Setting a data report

1. Press [F5] to display the Position Reports menu.

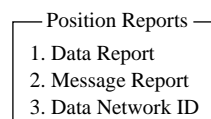

Figure 5-1 Position reports menu

2. Press [Enter] or [1] to display Data Report screen.
3. Press [1], [2], [3] or [4] to set addressee desired.  
You can set four addressees.

The cursor is on the Status line and “OFF” is selected.

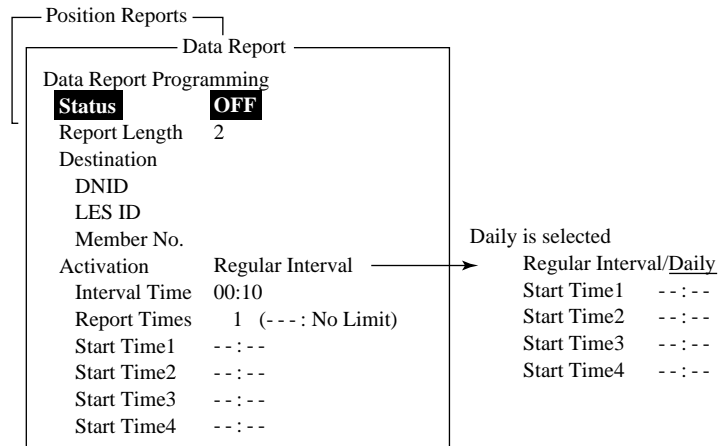

Figure 5-2 Data report menu

4. Press [Enter] to open the selection window.
5. Select “ON” or “OFF”.
  - ON: Data report on
  - OFF: Data report off
6. Press [Enter] to close the selection window.
7. Press [↓] to advance the cursor to the Report Length line.
8. Press [Enter] to open the selection window.
9. Select “1” or “2”.
  - 1: Position
  - 2: Position, speed, bearing, depth
  - 3: Spare (not used)
10. Press [Enter] to close the selection window.
11. Press [↓] to advance the cursor to the Destination line.
12. Press [Enter] to display the DNID list.
13. Select DNID.  
(LES ID and Member ID are automatically selected with DNID.)
14. Press [Enter] to close the DNID list.

**Note:** If the item "Activation" below is set to "Daily", do the following steps:

- 1) Press [↓] several times to select Report Times.
  - 2) Press the [Enter] key to show the screen for entry of transmission quantity.
  - 3) Press the [0] key or [Backspace] key to set No Limit.
  - 4) Press the [Enter] key to close the screen.
15. Press [↓] to advance the cursor to the Activation line.



16. Press [Enter] to open the selection window.
17. Select “Regular Interval” or “Daily”.
18. Press [Enter] to close the selection window.
19. Press [↓].
  - ˘ When “Regular Interval” is selected on step 17,
    - (1) Press [Enter] to open the window for interval time entry.
    - (2) Key in the interval time at Interval Time.
    - (3) Press [Enter] to close the window.
    - (4) Press [↓].
    - (5) Press [Enter] to open the window for report times entry.
    - (6) Key in the Report times or select “No limit”.
    - (7) Press [Enter] to close the window.
  - ˘ When “Daily” is selected on step 17,
    - (1) Press [Enter] to open the window for start time entry.
    - (2) Key in the start time at Start Time 1.
    - (3) Press [Enter] to close the window.
    - (4) Press [↓].
    - (5) If necessary, key in the start time of Start Times 2-4.
20. Press [Esc] to register the above settings.

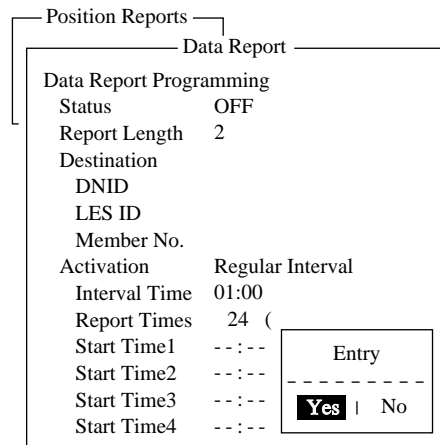

*Figure 5-3 Data report menu*

21. Select “Yes”.
22. Press [Enter] to close the Data Report window.

## Setting a message report

1. Press [F5] to display the Position Reports menu.

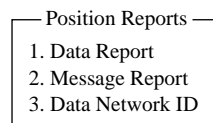

Figure 5-4 Position reports menu

2. Press [2] to display the Message Report.
3. Press [1], [2], [3] or [4] to set addressee desired.  
You can set four addressees.

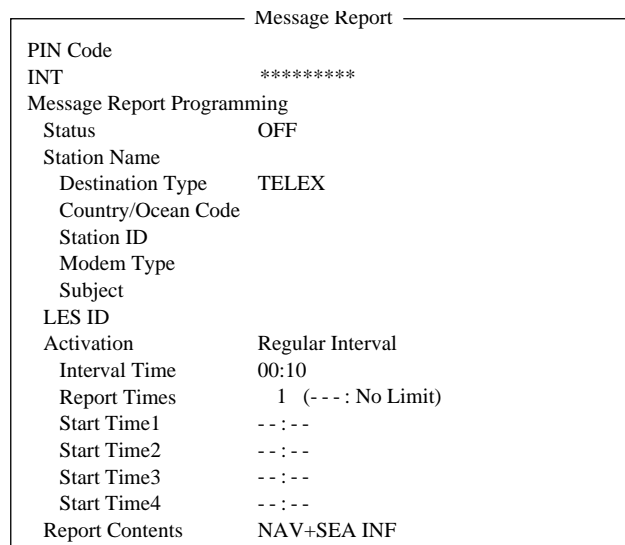

Figure 5-5 Message report menu

4. Press [Enter] to open the window for PIN code entry.
5. Key in the PIN code.  
PIN code (max. 8 digits) should be agreed upon with your recipient beforehand.
6. Press [Enter] to close the window.
7. Press [↓].
8. Press [Enter] to open the selection window.
9. Select “ON” or “OFF”.  
ON: Message report on  
OFF: Message report off
10. Press [Enter] to close the selection window.
11. Press [↓].
12. Press [Enter] to display the station list.
13. Select a station.

14. Press [Enter] to close the station list.
15. Press [↓] to place the cursor on the LES ID line.
16. Press [Enter] to display the LES list.
17. Select LES.
18. Press [Enter] to close the LES list.

*Note: If the item "Activation" below is set to "Daily", do the following steps:*

- 1) Press [↓] several times to select Report Times.
  - 2) Press the [Enter] key to show the screen for entry of transmission quantity.
  - 3) Press the [0] key or [Backspace] key to set No Limit.
  - 4) Press the [Enter] key to close the screen.
19. Press [↓].
  20. Press [Enter] to open the selection window.
  21. Select "Regular Interval" or "Daily".
  22. Press [Enter] to close the selection window.
  23. Press [↓].

˘ When "Regular Interval" is selected on step 21,

- (1) Press [Enter] to open the window for interval time entry.
- (2) Key in the interval time.
- (3) Press [Enter] to close the window.
- (4) Press [↓].
- (5) Press [Enter] to open the window for report times entry.
- (6) Key in the report times or select "No Limit".
- (7) Press [Enter] to close the window.

˘ When "Daily" is selected on step 21,

- (1) Press [Enter] to open the window for start time entry.
- (2) Key in the start time.
- (3) Press [Enter] to close the window.
- (4) Press [↓].
- (5) If necessary, key in the start time of Start Times 2-4.

24. Press [↓].
25. Press [Enter] to open the selection window.
26. Press [↑] or [↓] select the contents of message report.

NAV: Position, speed, bearing

NAV+SEAINF: Position, speed, bearing, water temperature,  
current, depth

27. Press [Esc] to register the above settings.

Message Report	
PIN Code	12345678
INT	*****
Message Report Programming	
Status	ON
Station Name	FRNINMBTSTSES
Destination Type	TELEX
Country/Ocean Code	583
Station ID	343199710
Modem Type	
Subject	
LES ID	303 (YAMAGUCHI)
Activation	Daily
Interval Time	01:00
Report Times	24 (---: No Limit)
Start Time1	08:00
Start Time2	--:--
Start Time3	--:--
Start Time4	--:--
Report Contents	NAV+SEA INF

Entry

-----

Yes | No

*Figure 5-6 Message Report Screen*

28. Select “Yes”.

29. Press [Enter] to finish.

## Polling

When the FELCOM 12 receives a polling command from your home office, it automatically transmits data to your home office. The data are position, speed, bearing and other data sent from a navigational equipment or an interface unit.

A polling command from your home office can also activate data report or message report if the corresponding setting is completed on the FELCOM 12. If a polling command with a file name is received, the FELCOM 12 transmits the file to your home office.

### Polling command

This paragraph shows you how to make the polling command at your home office.

There are two kinds of polling commands: one is sent on the MES signalling channel and the other is sent on the MES message channel.

#### Polling command on MES signalling channel

Request a land station to make the polling command because the format varies with land station.

## **Polling command on MES message channel**

To make the polling command, enter D???, hyphen, PIN code (max. 8 digits), hyphen, file name (stored in the floppy disk of the FELCOM 12), colon and text of message.

To send file data, type a hyphen and file name. If no hyphen and file name is entered, MES automatically transmits nav data (own ship position, course, speed, etc). For PIN Code setting refer to page 5-4.

D???-PIN code-file name: (text of message)

*Figure 5-7 Polling command*

## **Other polling command**

### **Telex**

P???/PIN Code/TELEX/LES number/Country number/Subscriber's number/File name:

### **E-mail**

P???/PIN Code/EMAIL/LES number/ E-mail address/File name:

### **Public Switched Telephone Network**

P???/PIN Code/PSTN/Modem type/LES number/Country number/Subscriber's number/File name:

Modem type is selected from T30, V21, V22B, V22, V23, V26B, V26T, V27T or V32.

### **Packet Switched Data Network**

P???/PIN Code/PSDN/LES number/Country number/Subscriber's number/File name:

### **Data Network Identification**

P???/PIN Code/DNID/LES number/Country number/Subscriber's number/File name:

### **Facsimile**

P???/PIN Code/FAX/LES number/Country number/Subscriber's number/File name:

### **Special**

P???/PIN Code/SPEC/LES number/Country number/Subscriber's number/File name:

For ship-to-ship communication, country number is ocean region number. Subscriber's number includes Station ID, Telex ID, etc. If file name is not specified (/:), position, speed, bearing, water temperature, current and depth are transmitted. Furthermore, / is deleted (:), position, speed and bearing are transmitted.

For example, you transmit polling command to MES of PIN code 12345678 via Yamaguchi station (Pacific Ocean: 203). Then, that MES transmits position, speed, bearing, water temperature, current and depth to telex number 720-5644325.

P??/12345678/TELEX/203/720/5644325/:

Mobile earth station transmit position, speed and bearing to e-mail address abc@furuno.co.jp.

P??/12345678/EMAIL/203/abc@furuno.co.jp:

## Polling reception

No operator intervention is required during polling reception.

The printer PP-510 prints the status of polling reception and data transmission in response to polling request as shown below.

```
-----  
Receive Message  
  
Message No.      : R0990907.002  
Message Ref. No. : 00616923  
LES             : YAMAGUCHI  
Priority        : Normal  
Message Size    : 121 characters  
Receive Data & Time : 99-09-09 04:07 (UTC)  
  
KDD INMARSAT-C SERVICE 9-SEP-1999 04:02:28 UTC REF:616923  
XXXXXXXXXX ABCD X via YAMAGUCHI LES  
  
D??-12345678:test test  
  
-----  
  
99-09-09 04:09 (UTC)  
Successful Sending message.  
  
-----  
Sent Message  
DELIVERY CONFIRMATION OFF  
  
Message File      : Report           Message Size : 284 characters  
LES              : YAMAGUCHI        Date         : 99-09-09  
Priority          : Normal           Time         : 04:09 (UTC)  
Destination      : TELEX           582 (IA5)  
  
582+  
Date & Time      : 99-09-09 04:07 (UTC)  
Position        : LAT 12:34.56N     Water Temp   : 32.1  
                : LON 123:45.67E   Water Current: 22.3 KTS  
Course          : 321.1              111.0  
Speed           : 1.1 KTS           Depth        : 123.4FT  
  
-----
```

*Figure 5-8 Sample MES message channel printout*

**Note:** You can turn off printing of the data report and polling commands as follows:

1. Press [F8], [6] to display the Auto Print Mode Setup screen.

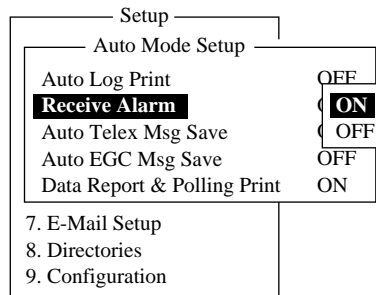

Figure 5-9 Auto print mode setup screen

2. Press the [↓] key to choose "Data Report & Polling Print."
3. Press the [Enter] key.
4. Choose OFF.
5. Press the [Enter] key.
6. Press the [Esc] key twice.

## DNID (Data Network Identification)

When you make a contract with an information provider, DNIDs are downloaded from the information provider to your FELCOM12 via an LES.

Up to 64 DNIDs can be downloaded to the FELCOM 12.

### Displaying DNID

1. Press [F5] to display the Position Reports menu.
2. Press [3] to display the Data Network ID screen.

Data Network ID						
RET: Activate SPACE: Inhibit Ctrl+P: Print ESC: Quit						
Mark '*' means activation.						
No.	Act	DNID	LES	Subaddr	Member	Text
01	*	00004	101	000	001	
02	*	00004	101	002	003	
03	*	23456	101	002	223	
04	*	03333	101	002	044	
05	*	03333	101	000	044	
06	*	07777	101	000	099	
07	*	09999	101	000	088	
08						
09						
10						

Figure 5-10 Data network ID menu

**Note:** DNID with “\*” mark are available for use(Refer to Figure 5-11).

```
-----  
POLLING Message --- Program Unreserved Data Reporting ---  
DNID :0004 LES ID :101 (Southbury)  
Sub Address :000 Member Number :001 Response: No Response  
Receive Data & Time: 97-04-15 00:01 (UTC)  
  
Start Frame: 00030 Interval: 00030  
-----  
97-04-15 00:01 (UTC)  
Data Report Program has been initiated by Polling.  
  
-----  
POLLING Message --- Initiate Unreserved Data Reporting ---  
DNID :0004 LES ID :101 (Southbury)  
Sub Address :000 Member Number :001 Response: Data Report  
Receive Data & Time: 97-04-15 00:01 (UTC)  
  
Start Frame: 00030 Interval: 00030  
-----  
Data Reported (Poll Response)  
LES :Southbury Date : 97-04-15  
DNID :0004 Time : 00:03 (UTC)  
Member No. :001  
  
Position LAT 10:14.03N  
LON 124:36.81E  
-----  
97-04-15 00:06 (UTC)  
Successful Data Report Sending.
```

*Figure 5-11 Sample MES signalling channel printout*

## Enabling/Disabling DNID

DNID can be enabled or disabled as follows:

1. Press up/down arrow key to place the cursor on the desired DNID.
2. Press [Enter] to enable the DNID. (\* mark appears.)  
Press [Enter] to disable the DNID. (\* mark disappears.)

**Note:** When a DNID is disabled “running data program (poll)” is displayed and polling is cancelled.

3. Press [Esc] to close the window.
4. To return to the standby display, press [Esc] twice.

**Note:** “Disable” not permitted in FFA version.



## Preparing a Distress Alert

1. Press [F8] to display the Setup menu. Note that this key has precedence over any operation.
2. Press [1] to display the Distress Message Setup screen.

Distress Alert Setup	
<b>LES ID</b>	<b>144</b>
Update Time	06:23 97-08-20 (YY-MM-DD)
Position	LAT 35:00N LON 135:00E
Protocol	Maritime
Nature	Undersigned
Course	187
Speed	10 KTS

*Figure 6-1 Distress Alert setup screen*

3. The default LES ID is 144, AOR-E, NCS. To change, press [Enter] to display the LES ID list. Select a suitable LES and press [Enter].
4. Press [ ↓ ] to select Update Time. Enter the time (hours and minutes and date) if necessary. The time indication stays still showing the last update. Current time and position are shown at the bottom right on the screen.
5. Press [ ↓ ] to select Position.
6. Press [Enter] to open the window for position entry.
7. Enter position in latitude and longitude. Use [→] to shift the cursor from degree to minutes and co-ordinate. Enter co-ordinate with appropriate alphabet key.
8. Press [Enter] to close the window.
9. Press [ ↓ ] to advance the cursor to the Protocol line.
10. For marine vessels Protocol should be set to Maritime.



# Transmitting a Distress Alert

1. Open cover on DISTRESS button.
2. Press the DISTRESS button 4 seconds on Distress Alert Unit IC-302.

**Note:** *Within 3 seconds, the distress alert will not be transmitted.*

The lamp inside the button flashes quickly and an audible alarm sounds intermittently. Four seconds later, the distress alert is transmitted and light the lamp and an audible alarm sounds continuously. When you receive acknowledgment of the distress alert from an LES, the lamp flashes slowly and the audible alarm sounds intermittently.

To silence the audible alarm, press [F10].

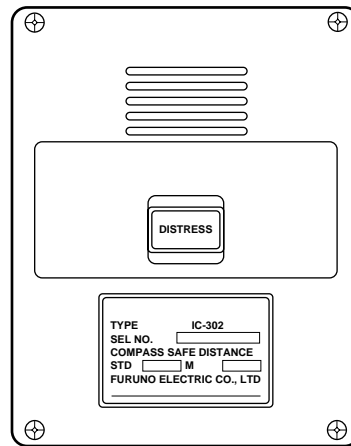

*Figure 6-4 Distress Alert Unit IC-302*

Do not press the button to silence an alarm for incoming distress or urgent message. This will transmit a distress alert for own ship.

## Testing Distress Button

The DISTRESS button on the IC-302 may be tested without transmitting the distress signal as follows:

1. Press [F7] to display the Options menu.
2. Press [6] to display the Test menu.

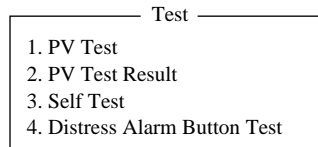

*Figure 6-5 Test Menu*

3. Press [4].
4. Press [Enter]. The Distress Alert Button Test mode screen appears.

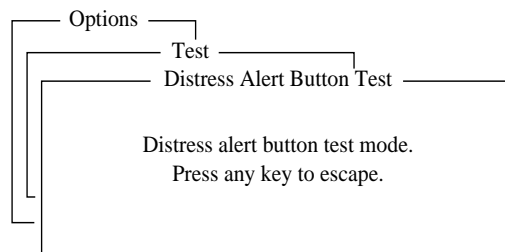

*Figure 6-6 Distress alert button mode screen*

5. Open cover on DISTRESS button.
6. Press the DISTRESS button 4 seconds.
7. Confirm that the IC-302 sounds the audible alarm.
8. Close the cover on DISTRESS button.
9. Press any key to escape.

# Distress Communications

The **distress alert** provides the minimum distress reporting requirements: own vessel's ID, speed, course, L/L position and nature of distress. After receiving the distress alert acknowledgment and you are not pressed for time you may send detailed information as follows:

1. Press [F1] followed by [Enter] to display the editor screen.
2. Prepare distress communication message. Figure 6-7 shows a sample distress message.

```
MAYDAY MAYDAY MAYDAY  
  
THE NAME IS ..... Ship's name  
  
I NEED HELP ..... : Type of assistance required
```

*Figure 6-7 Sample distress message*

3. Press [F3].
4. Press [Enter]. The screen should look something like Figure 6-8. The cursor is on the Priority line.

```
Transmit <[1] UNTITLED1>  
Transmit Message  
Priority Normal  
Message File Message now being edited Size 63  
Station Name  
Destination Type TELEX  
Prefix Code  
Country/Ocean Code  
Station ID  
Modem Type  
Address  
Subject  
Attach File  
LES ID  
Option  
[ TRANSMIT ]
```

*Figure 6-8 Transmit message screen*

5. Press [Enter] to open the selection window.
6. Press [ ↓ ] to select "Distress".
7. Press [Enter] to close the selection window.
8. Press [ ↓ ] to go the LES ID line.
9. Press [Enter] to open the LES list.
10. Select the LES where the distress alert was transmitted.

11. Press [Enter] to close the LES list.
12. Press [ ↓ ] to place the cursor on TRANSMIT.
13. Press [Enter]. The display should look similar to Figure 6-9.

The screenshot shows a terminal window titled '<[1] UNTITLED1>'. At the top left, the word 'Transmit' is displayed. Below it, the main area is titled 'Transmit Message'. The screen displays the following fields and values:

Priority	Distress	Size	63
Message File	Message now being edited		
Station Name			
Destination Type	TELEX		
Prefix Code			
Country/Ocean Code	000		
Station ID	SEARCH AND RESCUE		
Modem Type			
Address			
Subject			
Attach File			
LES ID	303 (YAMAGUCHI)		
Option			

At the bottom left, there is a prompt: [ TRANSMIT ]

At the bottom right, there is a confirmation box with the text 'Start' and a dashed line below it. Below the dashed line are two options: 'Yes' (which is highlighted with a black background) and 'No'.

*Figure 6-9 Transmit message screen with send start confirmation prompt*

14. Press [Enter] to transmit the distress message to the LES.

**Note:** *Country/Ocean Code and Station ID are not required in a distress message.*

# OTHER FUNCTIONS

This chapter describes how to abort operation, scan NCS and select EGC and NCS channels.

## Aborting an Operation

You can abort transmission, receiving or scanning during operation.

1. Press [F7] to display the Options menu.

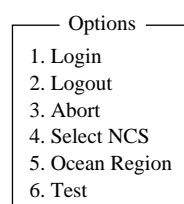

Figure 7-1 Options menu

**Note:** If the FELCOM 12 is set to operate as an EGC-only receiver, the menu looks like this:

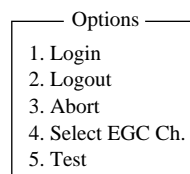

Figure 7-2 Options menu, EGC-only receiver status

2. Press [3] to select Abort.

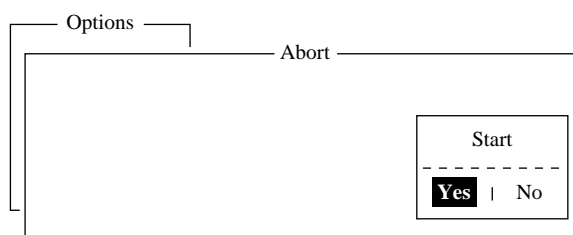

Figure 7-3 Abort screen

3. Press [Enter] to abort. (The message "Forced Clearing" replaces either Sending, Receiving or Scanning at the bottom of the screen.)

**Note:** Aborting is possible in sending, receiving or scanning. If attempted in other operating modes "Cannot abort current process." appears.

# Scanning NCS

The communication unit automatically tunes itself to the NCS selected on the System Setup menu. You can, however, tune to another NCS which has a stronger signal. Scanning is possible only when the communication unit is IDLE and FELCOM 12 is set to operate as an Inmarsat-C transceiver.

If the communication unit is not idle, “Communication unit is not Idle now. Cannot start scan.” appears. Press any key to escape then wait until the unit is in the idle state.

1. Press [F7] to display the Options menu.
2. Press [5] to display the Ocean Region screen.

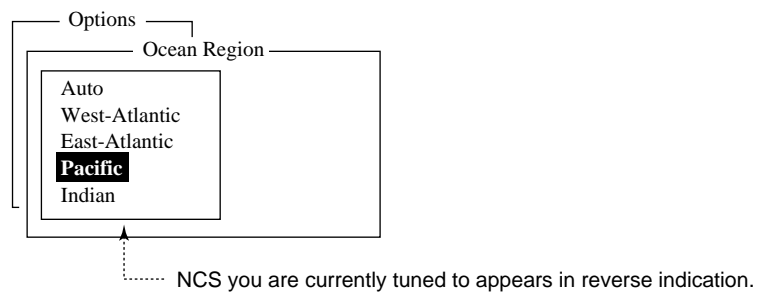

Figure 7-4 Ocean region screen

3. The NCS you are currently tuned to appears in reverse indication. If necessary, select another NCS.
4. Press [Enter].  
If Auto is selected, FELCOM 12 scans all NCSs in turn. If a particular ocean region is selected, FELCOM 12 scans all channels of that NCS. (NCSs will begin using multiple channels when the third generation satellites come into use.)

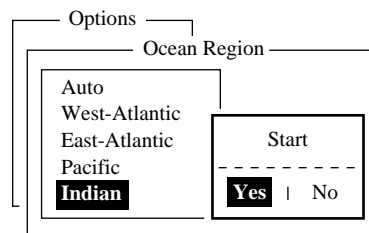

Figure 7-5 NCS scan confirmation screen

5. Press [Enter] to start the scanning.

*The message “Starting Scan Process. Press any key to escape.” appears during the scanning.*



# Selecting EGC Receiving Channel

EGC channel can be selected when the DTE is set to operate as an EGC-only receiver. This procedure is shown for reference; currently there is only one EGC channel per NCS.

1. Press [F8] to display the Setup menu.
2. Press [9] to display the Configuration menu.
3. Press [3]. The EGC channel which the EGC receiver is currently tuned to appears on the display in reverse indication.

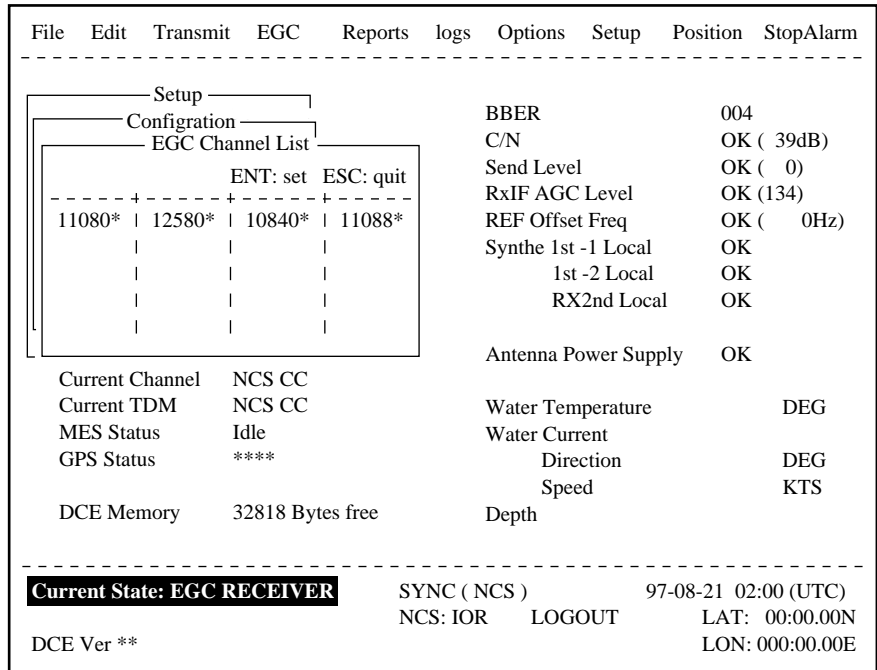

Figure 7-6 EGC channel list screen

4. Select desired channel.
5. Press [Enter] to start the tuning.
6. Press [Esc] to close the Update screen.
7. Press [Enter] to select “Yes”.

# Selecting NCS Channel

NCS channel can be selected as shown in the procedure below. Currently, each satellite transmits one global beam. In the future, the satellites will transmit multiple spot beams, namely, the NCS will have multiple channels.

1. Press [F7] to display the Options menu.
2. Press [4] to display the Select NCS menu. The NCS Channel List appears.  
NCS channels programmed at page 2-16 appear on the list.

Options

1. Login

NCS Channel List

ENT: set ESC: quit



No	AOR (WEST)		AOR (EAST)		POR		IOR	
	ID	FREQ	ID	FREQ	ID	FREQ	ID	FREQ
1	044	11080*	144	12580*	244	12580*	344	10840*
2	0		1		2		3	
3	0		1		2		3	
4	0		1		2		3	
5	0		1		2		3	
6	0		1		2		3	
7	0		1		2		3	
8	0		1		2		3	

Figure 7-7 NCS channel list

3. Select NCS channel.
4. Press [Enter].
5. Press [Esc] to close the Update screen.
6. Press [Enter] to select “Yes”.  
The unit tunes to the channel selected.

This chapter provides the information necessary for the maintenance and checking of the FELCOM 12.

## Safety Information

 <b>WARNING</b>					
	<p><b>Do not open the cover of the equipment.</b></p> <p>This equipment uses high voltage electricity which can shock, burn, or cause serious injury. Only qualified personnel should work inside the equipment.</p>				
	<p><b>Hazardous microwave</b> <b>Do not approach within 60 cm of the antenna radome when it is transmitting.</b></p> <p>Microwave radiation can be harmful to the human body, particularly the eyes.</p> <table border="1"><thead><tr><th>Radiation Level</th><th>At</th></tr></thead><tbody><tr><td>10W/m<sup>2</sup></td><td>60 cm</td></tr></tbody></table>	Radiation Level	At	10W/m <sup>2</sup>	60 cm
Radiation Level	At				
10W/m <sup>2</sup>	60 cm				
<p><b>Do not disassemble the equipment.</b></p> <p>Fire, electrical shock or serious injury may result.</p>					

# General Checking and Maintenance

Turn off the power before conducting any maintenance procedures other than the cleaning of the terminal unit and communication unit.

## Cleaning the terminal unit and communication unit

These units can be cleaned with a soft, dry cloth. DO NOT use chemical cleaners. They may remove paint and markings.

## Checking connectors and earth terminal

The connectors and earth terminal on the rear panel of the communication unit and on the bottom panel of the terminal unit should be checked periodically for tightness. If the earth terminal has rusted, clean it.

## Floppy disk drive head

The floppy disk is coated with a magnetic material which stores information entered into the disk. If this material is damaged by foreign material adhering to the disk drive head it may not be possible to read from or write to the disk. Clean the head regularly with a cleaning floppy disk to prevent loss of data.

## When the power can't be turned on (power lamp does not light)

3) and 4) are for service technicians.

- 1) Check the power cable connector on both the rear panel of the terminal unit and communication unit for tightness. Check if the ship's mains switchboard is turned on.
- 2) On the terminal unit, check the breaker on the rear panel. If it has tripped it will be protruding several millimeters. Reset it if necessary.
- 3) On the rear panel of the terminal unit, disconnect the power cable. Connect a multimeter to the power cable connector and confirm 21.6 and 31.2 V. (pin #1: positive, pin #2: negative)
- 4) On the rear panel of the communication unit, disconnect the power cable. Connect a multimeter to the power cable connector and confirm 21.6 and 31.2 V. (pin #1 and #2: positive, pin #3 and #4: negative)

# Self Tests

The communication unit and the terminal unit are equipped with self tests which check them for proper operation.

## Self test at power application (communication unit)

The communication unit performs the following tests when it is turned on:

- a) ROM sum test
- b) RAM read and write test
- c) DP RAM read and write test
- d) EEPROM sum test
- e) VITERBI decoder test

If the unit finds no fault it goes into normal operation.

## Testing the communication unit through the keyboard

This test can only be initiated from the main DTE. The communication unit must be idle.

1. Press [F7] to display the Options menu.
2. Press [6] to display the Test menu.
3. Press [3]. The Communication Unit (self test) screen appears.

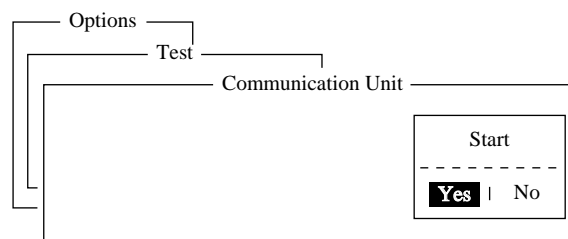

Figure 8-1 Communication unit screen

4. Press [Enter] to start the test.

The message “Now Communication Unit-testing” appears in blinking reverse video during testing.

- When the test is completed the screen shows the results of the test.

Options			
Test			
Communication Unit			
CPU1	165-0086-100	CPU2	165-0087-103
ROM	OK	ROM	OK
RAM	OK	RAM1	OK
DP-RAM	OK	RAM2	OK
Viterbi	OK	EEPROM	OK
		GPS	OK
		DP-RAM	OK
Press any key to escape.			

*Figure 8-2 Sample communication unit self test results*

Either “OK” or “NG” (No Good) appears next to each ROM and RAM tested. NG display releases the audible alarm. For defective ROM, RAM, DP-RAM, EEPROM or VITERBI replace the CPU Board. For GPS, NG appears when there is no GPS board or it is faulty.

- Press any key to finish the communication unit test.

## Performance Verification (PV) Test

After the FELCOM 12 is installed, the installing technician usually confirms that the unit is functioning properly and is logged in with the Inmarsat C system by conducting the PV test.

The PV test consists of the message reception test, message transmission test and distress alert test.

The results of the test appear on the PV test result display.

Note that the test cannot be conducted from a 2nd DTE. Note also that the test can be initiated by a LES.

### PV test sequence

- Select PV Test on the Test menu.
- The NCS acknowledges request for testing.
- The MES, upon receiving acknowledgment from NCS, goes into pending state.
- NCS will select a (not busy) LES to perform the test.
- The LES transmits a test message to the MES.
- MES transmits a test message to the designated LES.
- LES receives test message.

8. The MES automatically transmits the distress alert test within two minutes after completion of step 8.
9. When the distress alert test is finished the results of the test are sent to MES.

**The entire PV test can be conducted automatically (taking about 15 minutes in total).**

### PV test procedure

1. Confirm that the communication unit is in idle condition and logged in.
2. Press [F7] to display the Options menu.
3. Press [6] to display the Test menu.
4. Press [1] to select PV Test.

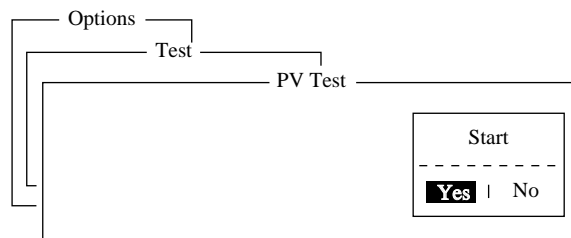

*Figure 8-3 PV test screen*

**Note:** *If the communication unit is not idle when the test is initiated the screen displays “MES is not idle now. Cannot start PVTest.” And if not logged in, “Cannot start PV Test. (not Logged-in)” appears.*

5. Press [Enter] to transmit the PV test request to NCS.

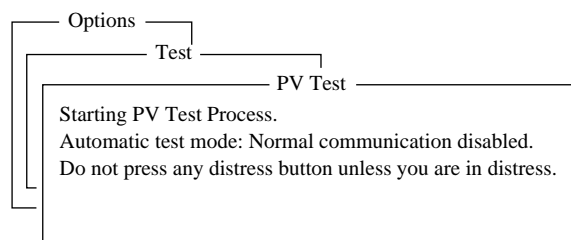

*Figure 8-4 PV test screen*

6. Press [Esc] to return to the standby display.
7. The screen displays “Current State: Idle (pending!)” when the acknowledge signal is received from the NCS.
8. When testing begins the screen displays “Current State: TESTING”.
9. Transmit a message to the LES. The LES, after acknowledging receipt of your message, transmits a message to you.

10. Though a prompt asks you to test distress alert, do not press any key. The alert test is automatically conducted two minutes later.
11. When testing is completed the indication TESTING is replaced by IDLE.
12. The test results appear on the PV Test Result screen. (The next section shows how to interpret the results.)

## Results of PV test

1. At the standby display, press [F7] to display the Options menu.
2. Press [6] to display the Test menu.

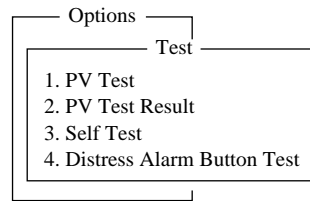

Figure 8-5 Test menu

3. Press [2] to display the results of the PV test.

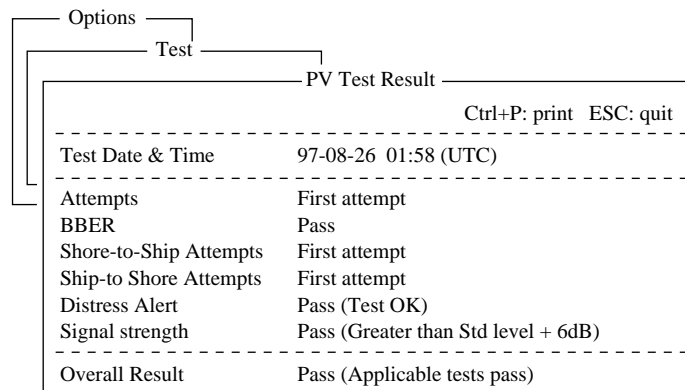

Figure 8-6 Sample PV test results

**Note:** *If the communication unit is off or malfunctioning, “DCE error: No response from DCE!!” appears. Check the connection between the communication unit and the terminal unit.*

4. To escape, press any key. The standby display appears.

## Interpreting the PV tests results display

**Test Date & Time:** Date and time of test

**Attempts:** Number of times the PV test was conducted.



<b>BBER:</b>	Bulletin Board Error Rate (%). Pass appears for no error.
<b>Shore-to-Ship Attempts:</b>	Number of tests initiated by LES.
<b>Ship-to-Shore Attempts:</b>	Number of tests initiated by MES.
<b>Distress Alert:</b>	“Pass (Test OK)” appears for successful testing.
<b>Signal Strength:</b>	“Pass” appears if signal strength is greater than standard level.
<b>Overall Result:</b>	“Pass” appears for satisfactory completion of test.

## System Status Monitor

The system status monitor, which is always displayed, provides date, time, equipment status and navigation data on one screen.

File	Edit	Transmit	EGC	Reports	logs	Options	Setup	Position	StopAlarm
Date			97-08-21			BBER		004	
Time			06:12 (UTC)			C/N		OK ( 38dB)	
						Send Level		OK ( 0)	
Position			LAT 35:00.00N			RxIF AGC Level		OK (133)	
			LON 135:00.00E			REF Offset Freq		OK ( 0Hz)	
Waypoint			LAT			Synthe 1st-1 Local		OK	
			LON			1st-2 Local		OK	
Course			DEG			RX2nd Local		OK	
Speed			KTS						
Current NCS			344 (IOR)	LOGIN		Antenna Power Supply		OK	
Current Channel			LES TDM						
Current TDM			LES TDM			Water Temperature		DEG	
MES Status			Busy			Water Current			
GPS Status			****			Direction		DEG	
						Speed		KTS	
DCE Memory			32818 Bytes free			Depth			
-----									
Current State: TESTING				SYNC ( LES )		97-08-21 06:12 (UTC)			
TEST--RECEIVING MESSAGE				NCS: IOR LOGIN		LAT: 35:00.00N			
DCE Ver 03 Oct-1996				LON: 135:00.00E					

Figure 8-7 System status monitor display

## Interpreting the system status monitor

<b>Date:</b>	Current date
<b>Time:</b>	Current time
<b>Position:</b>	Vessel's position (either manual entry or automatic input by navigation aid)
<b>Waypoint:</b>	Destination
<b>Course:</b>	Heading
<b>Speed:</b>	Ship's speed
<b>Current NCS:</b>	NCS your vessel is logged in with
<b>Current Channel:</b>	Channel in use
<b>Current TDM:</b>	Channel TDM
<b>MES Status:</b>	Operational status of MES
<b>GPS Status:</b>	Receiving signal status from GPS receiver. CST: Cold Start ACK: Acquired; Almanac data acquired IMP: Impossible; cannot receive GPS signal INT: Interrupted; object interfering reception of GPS signal ALM: Receiving the almanac 2D, 3D: Position-fixing method by 2 or 3 dimension

*Note: The above status indication depends on the GPS receiver connected.*

<b>DCE memory:</b>	Memory remaining in communication unit
<b>BBER:</b>	Bulletin Board Error Rate (%)
<b>C/N:</b>	Check of circuit status with LES, receiving circuit in antenna unit, RF CON Board and CPU Board (DEMOD section). OK appears for figure greater than 31.
<b>Send Level:</b>	TX level check. At transmission, OK appear for more than 123. At reception OK appears for figure less than 32.
<b>RX IF AGC Level:</b>	Check the receiving circuit of the antenna unit and the RF CON Board in the communication unit. OK appears for figure greater than 80.

<b>REF Offset Freq:</b>	Operating normally. If it does not light check RX Synthesizer or REF OSC in the RF CON Board. OK appears for figure less than 150.
<b>Synthe 1st Local:</b>	Check of RF CON Board.
<b>RX 2nd Local:</b>	Check of RF CON Board 2nd local oscillator.
<b>Antenna Power Supply:</b>	NG appears for discontinuity or short in cable.
<b>Temperature*:</b>	Water temperature
<b>Water Current*</b>	
<b>Direction:</b>	Tidal current direction
<b>Speed:</b>	Tidal current speed
<b>Depth*:</b>	Depth of water

*Note: \* requires data from the navigation device.*

## Replacing Internal Battery

A lithium battery in the communication unit is used to backup system settings. The life of this battery is about five years, however actual life depends on usage when the battery is dead the communication unit automatically reverts to default system settings. Contact you dealer to request replacement of the battery.

Name: BTT(L1)  
Code No.: 000-103-769  
Type: CR1/2 8.L-F

# Error Messages

This section shows the error messages which may appear on the screen and the means to remedy the associated problem. If normal operation cannot be restored, contact your dealer to request repair.

<b>Error message</b>	<b>Meaning</b>	<b>Action</b>
Signalling Channel congestion.	Signalling Packet (channel assignment request, distress call, data reporting, etc.) is transmitted, however SES signalling channel is busy	Try communicating again at a later time.
Lost TDM.	TDM (Time Division Multiplex) channel is not synchronized by shadow sector.	Error message will disappear after passing past shadow sector.
Too many retries.	Communication unit repeats same command	
Login failed.	Could not login.	Try communicating again at a later time. Suspect equipment trouble if login fails frequently
Timeout! Login Acknowledgement not received.	Login Acknowledgement is not received on time.	Try communicating again at a later time. Suspect equipment trouble if login fails frequently
Forced Clearing failed.	Forced clear failed	
Sending message failed.	Message could not be sent.	Try communicating again at a later time
Sending message aborted.	Sending message was aborted.	Try communicating again at a later time
Sending message aborted by LES because of ...	Sending message was aborted by LES (Land Earth Station).	Try communicating again at a later time
Selected LES not exist in current region.	You can not transmit to LES in current area.	Select different LES
MES Signalling Failure, during sending message.	SES signalling channel failed during sending message.	Retransmit again at a later time
Message sending failure, unauthorized DNID LES_ID pare.	Could not send message. LES could not accept DNID (Data reporting Network ID).	Select LES which handles DNID.

<b>Error message</b>	<b>Meaning</b>	<b>Action</b>
Delivery Status Request is failed.	Delivery status could not be confirmed	Re-request delivery status.
Delivery Status Request is aborted.	Delivery status request was aborted.	
Receiving message failed.	Message could not be received.	Message is re-received automatically.
Receiving message aborted.	Message aborted while being received.	Message is re-received automatically.
MES Signalling Failure, during receiving message.	SES signalling channel failed while message was being received.	Message is re-received automatically.
Receiving message aborted by LES because of ...		Message is re-received automatically.
Distress Alert Test aborted.	Distress alert test was aborted during PV test (Performance Verification test).	
Distress Alert Test failed.	Distress alert test failed during PV test (Performance Verification test).	Conduct PV test at a later time.
PV TEST is failed.		Conduct PV test at a later time.
PV TEST is aborted.		Conduct PV test at a later time.
MES Signalling Failure, during PV TEST.	SES signalling channel lost during PV test.	Conduct PV test at a later time.
Receiving Test Failure, Timeout while waiting on NCS CC.	NCS CC (Network coordination station common channel) receiving test failed.	Conduct PV test at a later time.
Sending Test Failure, Too many retries.		Conduct PV test at a later time.
PV TEST is aborted by LES because of ...		Conduct PV test at a later time.
PV TEST is pending by LES because of ...		PV test is re-started automatically.
PV TEST is rejected by LES because of ...		Conduct PV test at a later time.

<b>Error message</b>	<b>Meaning</b>	<b>Action</b>
Data Report failed, unauthorized DNID.	DNID (Data reporting Network ID) not set.	Select LES having DNID.
WARNING: BBER over 80%. Scanning NCS start manually.	BBER (Bulletin Board Error) rate exceeded 80%.	Select NCS manually or automatically.
WARNING: Can not find NCS CC in preferred region. Scanning all region is started.		If could not be found NCS CC, contact your dealer to request repair.
TROUBLE: Carrier power level.	Tx current could not, at transmission, be detected by SW REG.	Check system status monitor for send.
TROUBLE: Synthesizer UNLOCK.	Synthesizer circuit failure.	Request repair.
WARNING: Memory Full for receive message.	Could not save Rx message.	Turn on the Terminal Unit of connecting DTE1.
WARNING: Message received for DTE1 PORT. Please turn on DTE1 port equipment.	Communication between DTE1 (Terminal Unit) and Communication Unit failed.	Check the connecting between DTE1 and Communication Unit or turn on Terminal Unit.
WARNING: External NAV equipment failure.	No navigation data input from navigation device.	Check navigation device.
INF: Please update current ship position.	Current ship position is not updated.	Update current ship position.
WARNING: Internal GPS UNIT failure.	GPS signal could not be detected.	Internal GPS unit might be damaged if this message is displayed frequently. Contact your dealer to request repair.
Ignored: PV TEST has been already started, and now pending.	You attempted to conduct PV test when PV test is already pending.	
LES hardware error detected.	LES can not receive message or message was not accepted five times.	Tx system is unstable or equipment trouble.

<b>Error message</b>	<b>Meaning</b>	<b>Action</b>
LES protocol error detected.		Suspect trouble if when this message is displayed frequently.
invalid service.		Input correct service code.
invalid address.		Input correct address.

This page is intentionally left blank.



# SPECIFICATIONS

---

<b>Transmitting Frequency</b>	1626.5 to 1646.5 MHz
<b>Receiving Frequency</b>	1530.0 to 1545.0 MHz
<b>Antenna</b>	Omnidirectional
<b>G/T</b>	Better than -23 dB/K (elevation angle 5°)
<b>EIRP</b>	12 to 16 dBW (elevation angle 5°)
<b>Modulation</b>	BPSK
<b>Modulation Rate</b>	1200 sps
<b>Coding</b>	Convolutional coding with coding rate 1/2 and constraint length 7
<b>Decoding</b>	Viterbi decoder
<b>Transmission Speed</b>	600 bps
<b>External Equipment Interface</b>	Input: GGA, GLL, RMA, RMC, ZDA, VTG, RMB, WPL, MTW, DBT, VDR, BWC, BWR Output: GGA, ZDA, GLL, VTG, RMC, GSV
<b>Internal GPS Receiver (option)</b>	Eight discrete channels, all-in-view Approx. 50 m, 95% of the time, Horizontal dilution of position (HDOP) ≤ 4 All GPS receivers are subject to degradation of position and velocity accuracies under the U.S. Department of Defense.
<b>Navigation Equipment Interface</b>	Internal GPS Board (option): NMEA0183
<b>Operating Environment</b>	<u>Above deck equipment</u>  Temperature: -35°C to +55°C Relative humidity: 95% (at 40°C)  <u>Below deck equipment</u>  Temperature: -20°C to +55°C Relative humidity: 95% (at 40°C)
<b>Ship's Mains</b>	Communication unit, Terminal unit and Printer: 24VDC 100/110/120/200/220/240 VAC by optional AC-DC Power Supply Unit PR-300]

**Power Consumption**

IC-112 & IC-212: Receiving 25W, Transmitting 120W  
IB-581: 18W  
PP-510: 36 W MAX

**Color**

Antenna unit: N9.5  
Antenna unit base: 2.5PB3.5/10  
Communication unit: N3.0  
Terminal unit: Cover: 2.5GY5/1.5  
Panel: N3.0  
Distress alert unit: 2.5GY5/1.5  
Received call unit: 2.5GY5/1.5

**Waterproofing:**

Antenna unit: IEC529 IPX6  
Communication unit: IEC529 IPX2  
Terminal unit: IEC529 IPX0

## International Telex/Telephone Country Code List

Area and Country	Telephone Country Code	Telex Country Code	Remarks for Telex Code
Afghanistan	93	79	
Alaska	1	200	
Albania	355	604	
Algeria	21	408	
American Samoa	684	770	
American Virgin Is.	1	208	Telex calls to former WUI subscribers, insert the figure "9" after the destination code "208".
Andorra	33	590	
Angola	244	991	
Anguilla	1	391	
Antigua & Barbuda	2	393	
Argentina	54	33	Disregard the figure "0" at head of subscriber number.
Armenia	7	684	
Aruba	297	303	Subscriber numbers are 2XXX or 5XXX
Ascension	247	939	Manual calls 3XXX
Australia	61	71	
Australian External Territories	672	766	
Austria	43	47	
Azerbaijani	994	784	
Azores Is.	351	404	Destination code is the same as for Portugal.
Bahamas	1	297	
Bahrain	973	490	
Bangladesh	880	780	
Barbados	1	392	
Belarus	7	681	
Belgium	32	46	
Belize	501	371	
Benin	229	972	
Bermuda	1	290	
Bhutan	975	890	
Bolivia (Rep. of)	591	371	
Bolivia (ENTAL)		309	
Bosnia-Herzegovina	387	600	
Botswana	267	962	
Brazil	55	38	Disregard the figure "0" at head of subscriber number.
British Virgin Is.	1	292	
Brunei Darussalam	673	809	
Bulgaria	359	67	
Burkina Faso	226	978	
Burundi	257	903	

Area and Country	Telephone Country Code	Telex Country Code	Remarks for Telex Code
Cambodia	855	807	Kampuchea Rep.
Cameroon	237	970	
Canada	1	{ 21 26	Disregard the figure "0" at head of subscriber number.
Canary Is.	34	52	Destination code is the same as for Spain.
Cape Verde	238	993	
Cayman Is.	1	293	
Central Africa Rep.	236	971	
Chad	235	976	
Chile	56	34	{ TCH subscribers 2XXXXX ENTEL subscribers 5XXXXX TRA subscribers 3XXXXX TECOM subscribers 6XXXXX VTR CM subscribers 4XXXXX
China	86	85	
Christmas Is. (Aus)	672	766	
CIS (formerly USSR)	7	64	
Cocos-Keeling Is.	672	766	
Colombia	57	35	Disregard the figure "0" at head of subscriber number.
Comoros	269	994	Manual calls
Congo	242	981	
Cook Is.	682	772	
Costa Rica	506	376	
Cote d' Ivoire	225	983	Ivory Coast
Croatia	385	599	
Cuba	53	28	
Cyprus	357	605	
Czechoslovakia	42	66	
Denmark	45	55	
Diego Garcia	246	938	
Djibouti	253	979	
Dominica	1	394	
Dominican Rep.	1	{ 201 202 241	RCA subscribers 4XXXXX For subscriber number beginning with 346, disregard "346" at head of subscriber number. AGEM IR subscribers 61XX
Ecuador	593	308	
Egypt	20	91	
El Salvador	503	373	
Estonia (formerly USSR)	372	537	
Ethiopia	251	980	

Area and Country	Telephone Country Code	Telex Country Code	Remarks for Telex Code
Falkland Is. (Malvinas)	500	306	
Faroe Is.	298	502	
Fiji	679	701	
Finland	358	57	
France	33	42	
French Guiana	594	300	
French Polynesia	689	702	
Gabon	241	973	
Gambia	220	996	
Georgia	7	683	
Germany (Fed, Rep. of)	49	{ 69	formerly East Germany
	49	{ 41	formerly West Germany
Ghana	233	94	
Gibraltar	350	405	
Greece	30	601	
Greenland	299	503	
Grenada	1	395	
Guadeloupe	590	299	
Guam (RCA)	671	700	
Guatemala	502	372	
Guiana	594	300	
Guinea Conakry	224	995	Manual calls
Guinea Bissau	245	969	
Guyana	592	295	
Haiti	509	203	RCA subscribers 9XXX
		{ 704	RCA subscribers 8XXX or 2968XX
		{ 705	ITT subscribers 743XXX
Hawaii	1	{ 708	WUI subscribers 63XXX or 63XXXX
		{ 709	WUH subscribers 39XXXX
		{ (773)	Telex calls to HTC subscribers can be made using Semi-automatic calls.
Honduras	504	374	
Hong Kong	852	802	
Hungary	36	61	
Iceland	354	501	
India	91	81	
Indonesia	62	73	Disregard the figure "0" at head of subscriber number.
Iran	98	88	
Iraq	964	491	
Ireland	353	500	
Israel	972	606	Disregard the figure "0" at head of subscriber number.
Italy	39	43	

Area and Country	Telephone Country Code	Telex Country Code	Remarks for Telex Code
Jamaica	1	291	
Japan		72	KDD (for 5 digits)
	81	720	NTT
Jordan	962	493	
Kazakhstan	7	785	
Kenya	254	987	
Kiribati	686	761	Subscriber numbers are 770XX
Korea (Demo, People's Rep. of)	850	(899)	
Korea (Rep. of)	82	801	
Kuwait	965	496	
Kyrgyzstan	7	788	
Lao	856	804	
Latvia (formerly USSR)	371	538	
Lebanon	961	494	
Lesotho	266	963	
Liberia	231	997	
Libya	21	901	
Liechtenstein	41	45	
Lithuania (formerly USSR)	370	539	
Luxembourg	352	402	
Macao	853	808	
Macedonia	389	597	
Madagascar	261	986	Subscriber number beginning with 4, 5, 7, 8 and 9 can be reached by Manual Calls.
Madeira Is.	351	404	Destination code is the same as for Portugal.
Malawi	265	904	
Malaysia	60	84	
Maldives Is.	960	896	
Mali	223	985	
Malta	356	{ 406	Subscriber number beginning with 11XX can be reached by Semi-automatic calls.
		{ 403	
Mariana Is.	671	760	
Marshall Is.	692	765	
Maritinique	596	298	
Mauritania	222	974	
Mauritius	230	966	
Mexico	52	22	Disregard the figure "0" at head of subscriber number.
Micronesia	691	764	
Moldova	373	682	
Monaco	33	42	Destination code is the same as for France.
Mongolia	976	800	

Area and Country	Telephone Country Code	Telex Country Code	Remarks for Telex Code
Montserrat	1	396	
Morocco	21	407	
Mozambique	258	992	
Myanmar (formerly Burma)	95	83	
Namibia	264	908	
Nauru	674	775	
Nepal	977	891	
Netherlands	31	44	
Netherlands Antilles	599	390	
New Caledonia	687	706	
New Zealand	64	74	
Nicaragua	505	375	
Niger	227	975	2XXXX other numbers are for Semi-automatic calls.
Nigeria	234	905	
Niue Is.	683	776	
Northern Mariana Is.	670		
Norfolk Is.	672	766	
Norway	47	56	
Oman	968	498	
Pakistan	92	82	
Palau	680	763	
Panama	507	377	TRT subscribers
		378	AACR subscribers
		379	INTEL subscribers
Papua New Guinea	675	703	
Paraguay	595	305	
Peru	51	36	
Philippines	63	75	PHILCOM subscribers 2XXXX
			RCPI subscribers 7XXXX
			GMCR subscribers 4XXXX
			ETPI subscribers 6XXXX
			CAPWIRE subscribers 1XXXX
			For PTT subscribers, insert the figure "8" after the destination code "75".
Poland	48	63	Disregard the figure "0" at head of subscriber number.
Portugal	351	404	
Puerto Rico	1	205	RCA subscribers 2XXX
		206	ITT subscribers 345XXX
		207	C&W, WUI subscribers
		209	ACPR (PRCA) subscribers
Qatar	974	497	

Area and Country	Telephone Country Code	Telex Country Code	Remarks for Telex Code
Reunion	262	961	Subscriber numbers are 916XXX
Romania	40	65	Disregard the figure "0" at head of subscriber number.
Russian Federation	7	64	
Rwanda	250	909	
Saipan	670	760	
San Marino	378	505	
Sao Tome & Principe	239	967	Manual calls
Saudi Arabia	966	495	
Senegal	221	906	
Seychelles	248	965	
Sierra Leone	232	998	
Singapore	65	87	
Slovak	42	66	
Slovenia	386	598	
Solomon Is.	677	778	
Somalia	252	900	
South Africa	27	95	{ Cape Town subscribers XXXXXX Bophuthatswana subscribers 08XXXX Transkei subscribers 09XXXX
Spain	34	52	
Spanish North Africa	34	52	
Sri Lanka	94	803	
St. Helena	290	(960)	Manual calls 4XXX
St. Kitts & Nevis	1	397	
St. Lucia	1	398	
St. Pierre & Miquelon	508	204	
St. Vincent & the Grenadines	1	399	
Sudan	249	984	
Suriname	597	304	
Swaziland	268	964	
Sweden	46	54	
Switzerland	41	45	
Syria	963	492	
Tajikistan	7	787	
Taiwan	886	769	
Tanzania	255	989	
Thailand	66	86	
Togo	228	977	
Tokelau	690	762	
Tonga	676	777	
Trinidad & Tobago	296	294	
Tunisia	21	409	
Turkey	90	607	
Turkmenistan	7	789	



Area and Country	Telephone Country Code	Telex Country Code	Remarks for Telex Code
Turks & Caicos Is.	1	296	
Tuvalu	688	774	
U. A. E.	971	893	
Abu Dhabi			2XXXX, 3XXXX, 5XXXX
Ajman			695XX
Dubai			4XXXX
Fujairah			8XXXX
Ras Al Khaimah			9XXXX
Sharjah			68XXX
Umm Al Qaiwain			697XX
Uganda	256	988	
Ukraine	7	680	
United Kingdom	44	51	
United Arab Emirates	971	893	
Upper Volta	226	978	Same as "Burkina Faso".
Uruguay	598	32	
Uzbekistan	7	786	
U. S. A.	1	23	CCI subscribers 7XXXXXX ITT subscribers 4XXXXX, 4XXXXXXX, 4XXXXXXXXXX RCA subscribers 2XXXXX WUI subscribers 6XXXXX, 6XXXXXX, 6XXXXXXX
U. S. A. (Mainland)		23	TRT subscribers 1XXXXX, 1XXXXXXXXXX FTCC subscribers 8XXXXX, 8XXXXXX GRPHNET subscribers 36XXXXX, 37XXXXX For WUT subscribers, insert the figure "0" after the destination code "23".
		25	Telex calls to TWX subscribers whose numbers do not contain "0" as the third figure of the 10 figure code can be made as Semi-automatic calls.
U. S. S. R. (Former)	7	640	Russian Federation
Vanuatu	678	771	
Vatican	379	504	
Venezuela	58	31	
Viet Nam	84	805	Subscriber number beginning with 561XXX can be made using manual calls
Wallis & Futuna Is.	681	707	
Western Samoa	685	779	
Yemen (Rep. of)	969	806	Formerly Yemen (P. D. Rep. of)
Yugoslavia (Former)	967	895	Formerly Yemen (Arab Rep.)

<b>Area and Country</b>	<b>Telephone Country Code</b>	<b>Telex Country Code</b>	<b>Remarks for Telex Code</b>
Zaire	243	982	Telex calls to places other than Kinshasa Subscriber beginning with 2XXXXX can be made as Semi-automatic calls.
Zambia	260	902	
Zanzibar	259	990	
Zimbabwe	263	907	
<b>Ocean Area</b>	<b>Telephone Ocean Region Access Code</b>	<b>Telex Ocean Region Access</b>	<b>Remarks</b>
AOR-W	874	584	Atlantic Ocean-W
AOR-E	871	581	Atlantic Ocean-E
POR	872	582	Pacific Ocean
IOR	873	583	Indian Ocean

# International Telex Abbreviations

Abbreviation	Meaning
ADV	Advise
ACK	Acknowledge
AGN	Again
BI (GS)	Good bye
BK	I cut off.
CFN	Confirm
COL	Collation
CRV	How do you receive?
DER	Out of order
DWN	Down
EEE	Error
FM	From
GA	Go ahead.
MNS	Minutes
MOM	Wait (Waiting)
MUTI	Mutilated
NA	Correspondence to this subscriber is not admitted.
NC	No circuits
NCH	Subscriber's number has been changed.
NP	The called party is not or no longer is a subscriber.
NR	Indicate your call number.
OCC	Subscriber is engaged.
OK	Agreed.
P (or 0)	Stop your transmission.
PLS (PSE)	Please
PPR	Paper
P (RCD)	Received
RAP	I will call you again.
RD	Reed
RE	Referring to
RPT	Repeat
SRY	Sorry
SVP	Please
TAX	What is the charge?
TEST MSG	Please send a test message?
THRU	You are in communication with telex position
TKS (TNX)	Thanks
TLX	Telex

# Glossary of Acronyms

Acronym	Meaning
AOR-E	Atlantic Ocean Region-East
AOR-W	Atlantic Ocean Region-West
BB	Bulletin Board
BBER	Bulletin Board Error Rate
BPSK	Binary Phase Shift Keying
BS	Back Space
C/N0	Carrier to Noise Power Spectral Density
CNID	Close Network ID
CPU	Central Processing Unit
CSDN	Circuit Switched Data Network
DCE	Data Circuit Terminating Equipment
DP-RAM	Dual-Port Random Access Memory
DTE	Data Terminal Equipment
EGC	Enhanced Group Call
EIRP	Equivalent Isotropically Radiated Power
FD	Floppy Disk
GPS	Global Positioning System
G/T	Gain to Noise Temperature Ratio
HPA	High Power Amplifier
IA5	International Alphabet No.5
ID	Identity
IMO	International Maritime Organization
INMARSAT	International Mobile Satellite Organization
IOR	Indian Ocean Region
ISDN	Integrated Services Digital Network
ITA2	No.2 International Telegraphy Alphabet
ITU	International Telecommunications Union
LES	Land Earth Station
LNA	Low Noise Amplifier
MES	Mobile Earth Station
MSI	Maritime Safety Information
NAVAREA	Navigational Area
NAVTEX	MF Navigational Broadcast Service
NCS	Network Coordination Station
NMEA	National Maritime Electronics Association
OCC	Operation Control Center
PEP	Packet Error Probability
POR	Pacific Ocean Region
PSDN	Packet Switched Data Network
PSTN	Public Switched Telephone Network
PVT	Performance Verification Test
RAM	Random Access Memory
RCC	Rescue Coordination Center
ROM	Read Only Memory
SCC	Satellite Control Center
SFU	Store and Forward Unit
SOLAS	Safety of Life at Sea
TDM	Time Division Multiplex
TDMA	Time Division Multiple Access
UTC	Coordinated Universal Time
WMO	World Meteorological Organization

# International Telegraphy Alphabet

No.	FIGURES	LETTERS	No.	FIGURES	LETTERS
1	—	A	17	1	Q
2	?	B	18	4	R
3	:	C	19	,	S
4	+	D	20	5	T
5	3	E	21	7	U
6	□	F	22	=	V
7	■	G	23	2	W
8	◻	H	24	/	X
9	8	I	25	6	Y
10	BELL	J	26	+	Z
11	(	K	27	CARRIAGE RETURN	
12	)	L	28	LINE FEED	
13	.	M	29	LETTERS	
14	,	N	30	FIGURES	
15	9	O	31	SPACE	
16	0	P	32	BLANK	

# Error Messages and Alerts

**A file by that name already exists on FD.**

This message appears when you attempt to copy a file from the internal memory to a floppy disk and a file by that name already exists on the disk.

**Cannot use this LES. Please check network configuration.**

You input an invalid LES ID.

**Cannot abort current process.**

The terminal unit displays this message if you try to stop the DCE in operating condition other than sending, receiving or scanning.

**Cannot activate distress alert test.**

Distress alert testing cannot be done without permission from LES.

**Cannot enter this message to sending Queue.**

This message appears when a message is sent to the message queue and it is full (two messages maximum).

**Cannot start PV Test. (not Logged-in)**

You cannot start PV testing without first logging in.

**Cannot start to send. (EGC Receiver)**

Transmission is not possible when the FELCOM 12 operates as a EGC-only receiver.

**Cannot start to send. (not Logged-in)**

A message cannot be transmitted without first logging in.

**Close a file in use to make a new file.**

The working areas are full (capacity: two files). Close a file to load a file to a working area.

**Communication Unit is not Idle now. Cannot start login.**

Cannot login when the communication unit is not idle.

**Communication unit is not Idle now. Cannot start scan.**

This message appears when the FELCOM 12 operates as a EGC-only receiver and scanning is initiated when the communication unit is not idle. Wait until the unit is idle before starting scanning.

**Communication Unit is not Idle now. Cannot start logout.**

Cannot logout when communication unit is not idle.

**Current State : Idle (pending!)**

This message appears when a LES affirmatively acknowledges your request for PV testing.

**Current State : Testing** You will see this display during PV testing.

**DCE Error : No response from DCE!!**

This message appears when you try to display the PV test results and there was no response from the communication unit because it is off or its interconnection cable is disconnected or damaged.

**Distress Message updated. Press any key.**

This message appears after you have correctly updated the distress message.

**Distress Alert Acknowledgment Received**

This alert will appear when the LES transmits the distress acknowledge signal to your vessel.

**FD not inserted in drive.**

You need to insert a floppy disk into the drive.

**FD not inserted in drive. Press any key to escape.**

This message appears if you attempt to format a disk and there is no disk in the drive.

**File by that name already exists. OK to overwrite?**

This alert asks you if it is alright to write over an existing file name.

**Formatting Completed.** This alert appears upon completion of floppy disk formatting.

**Input Error : Message File**

You have manually input an invalid file name.

**Internal GPS unit failure.**

This message appears when the internal installed GPS unit is not working or is faulty. When the navigation port is not set to "INT", this message does not appear.

**Invalid Frequency Code.**

This message appears when a wrong frequency code is entered in the EGC Channel List or NCS Channel List.

**Invalid NCS ID Code.** This alert appears when a wrong NCS ID code is entered.

**Loading**

Appears during loading of a file to a working area.

**Message file is too big (partial transmission possible).**

The size of the file you want to send is larger than 31,500 bytes. (The file can be sent, but only the first 32,000 bytes of information will be received.)

**Message is entered in sending buffer.**

Before a message is transmitted it is sent to the message queue. This alert informs you the message has been accepted by the message queue.

**Message Send failed.** Could no send message because of satellite malfunction, etc.

**Message Send pending.** All circuits occupied at LES.

**Message Send rejected.** This alert appears when the LES rejects a message because of unpaid subscriber's fee or other reasons.

**No response from communication unit!**

This message will appear if the communication unit is turned off or its interconnection cable is disconnected or damaged.

**Now Self-testing Terminal. (cannot abort)**

Appears during testing of terminal unit.

**Now printing**

Appears during printing.

**Now Formatting**

Appears during formatting of floppy disk.

**OK to delete file?**

This alert verifies if it is alright to delete a file.

**OK to format FD?**

This alert verifies if it is alright to format a floppy disk.

**Printer error!!**

The printer is off or malfunctioning.

**Request started**

This message appears when requesting delivery status of a message.

**SAVING**

You will see this message when saving a file.

**SES is not idle now. Cannot start PV Test.**

This message means you will have to wait until the communication unit is idle to start the PV test.

**Starting Scan Process Press any key to escape.**

This prompt appears before scanning NCS.

**Update error! Retry again. Press RET to update end.**

This message appears if the distress alert message was updated incorrectly.



## LES IDs List

Land earth station operator	Country	AOR- E	AOR- W	IOR	POR
Beijing Marine	China			311	211
Bezeq	Israel	127		327	
CAT	Thailand			319	
CP Radio Marconi	Portugal	118			
Embratel	Brazil	114			
France Telecom	France	121	021	321	221
France Telecom (Ex DeteSat)	France	115		333	
KDDI	Japan	103	003	303	203
Korea Telecom	South Korea			308	208
Morviasputnik (Nudel Les)	Russia	117		317	
OTE	Greece	120		305	
Polish Telecom	Poland	116		316	
Saudi Telecom Co	Saudi Arabia	125		325	
Singapore Telecom	Singapore			328	210
Stratos Mobile Networks	Canada	102	002	302	202
Telecom Company of Iran	Iran			314	
Telecom Italia	Italy	105		335	
Telenor Satellite Services Inc	USA	101	001		201
Telenor Satellite Services AS	Norway	104	004	304	204
Turk Telecom	Turkey	110		310	
Vishipel	Vietnam			330	
VSNL	India			306	
Xantic	Netherlands	112	012	312	212
Xantic	Australia	122	022	322	222

# Digital Interface (IEC 61162-2)

## Input sentences

GGA, GLL, RMA, RMC, ZDA, VTG, RMB, WPL, MTW, DBT, VDR, BWC, BWR

## Output sentences

GGA, ZDA, GLL, VTG, RMC, GSV

## Transmission interval

GLL, GGA, VTG, RMC: 2 s

ZDA: 1 s

GSV: 10 s

## Data transmission

Data is transmitted in serial asynchronous form in accordance with the standard referenced in 2.1 of IEC 61162-2. The first bit is a start bit and is followed by data bits, least-significant-bit as illustrated below.

The following parameters are used:

Baud rate: 4800

Data bits: 8 (D7 = 0), parity none

Stop bits: 1

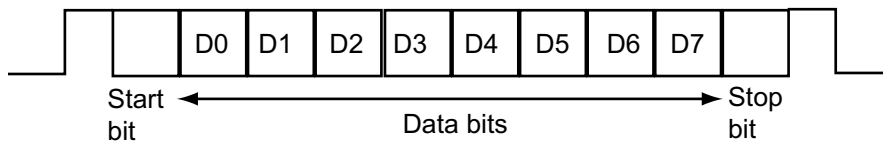

# Schematic diagrams

## NAV IN port (listener)

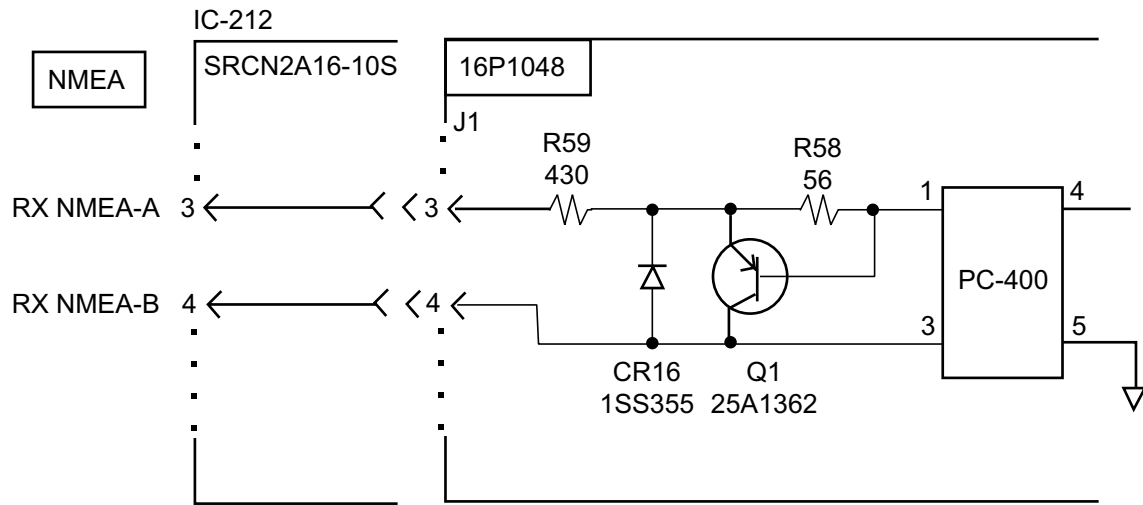

### Load requirements

Isolation: Optocoupler  
 Input Impedance: 486ohm  
 Max. Voltage: ±15V

## NAV OUT port

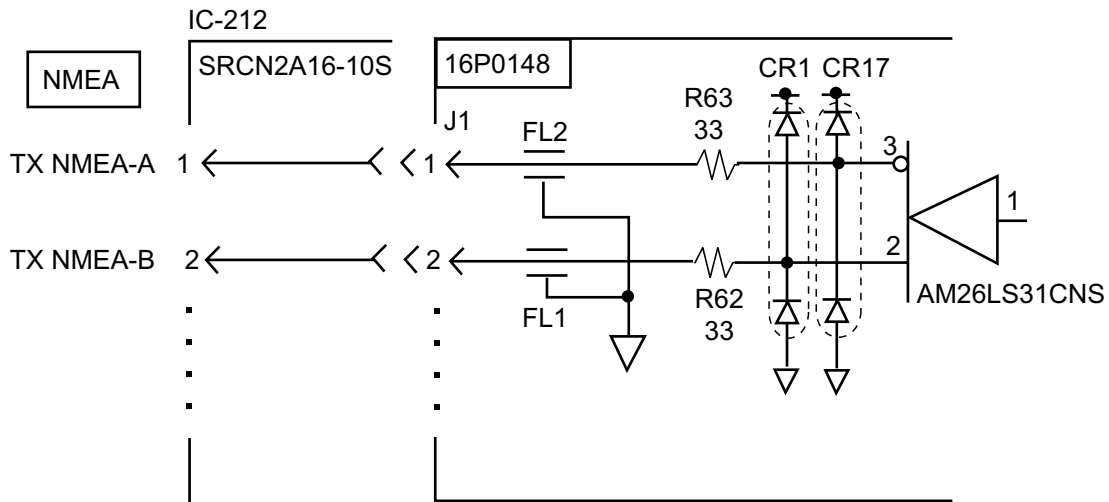

# Data sentences

## Input sentences

### **BWC - Bearing and distance to waypoint**

\$--BWC, hhmmss.ss, llll.ll, a yyyyy.yy, a, x.x, T, x.x, M, x.x, N, c--c, a\*hh<CR><LF>

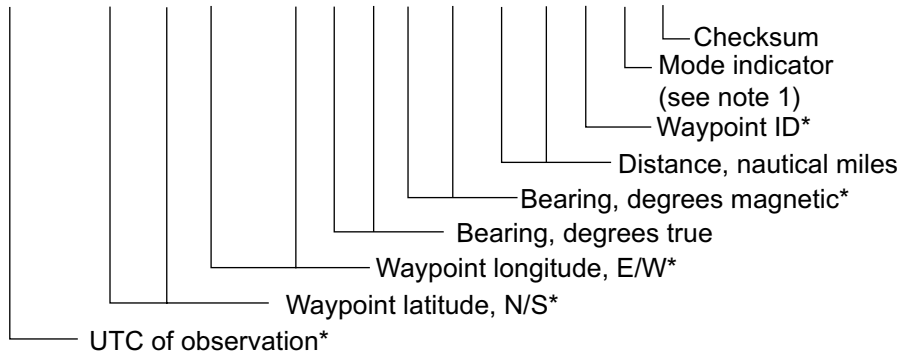

\*: Not used

NOTE 1: Positioning system Mode indicator:

- A = Autonomous
- D = Differential
- E = Estimated (dead reckoning)
- M = Manual input
- S = Simulator
- N = Data not valid

The Mode indicator field shall not be a null field.

## BWR - Bearing and distance to waypoint -rhumb line

\$--BWR,hhmmss.ss,lll.lll,a,yyyyy.yyy,a,x.x,T,x.x,M,x.x,N,c--c,a\*hh<CR><LF>

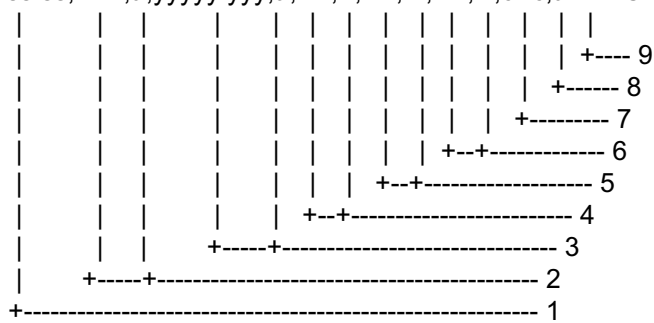

1. UTC of observation
2. Waypoint latitude, N/S
3. Waypoint longitude, E/W
4. Bearing, degrees true
5. Bearing, degrees magnetic
6. Distance, nautical miles
7. Waypoint ID
8. Mode indicator(see note)
9. Checksum

NOTE Positioning system Mode indicator:

- A = Autonomous
- D = Differential
- E = Estimated (dead reckoning)
- M = Manual input
- S = Simulator
- N = Data not valid

The Mode indicator field shall not be a null field.

## DBT - Depth below transducer

\$--DBT,x.x,f,x.x,M,x.x,F\*hh<CR><LF>

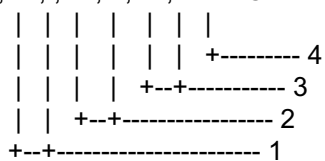

1. Water depth, feet
2. Water depth, m
3. Water depth, fathoms
4. Checksum

## GGA - Global positioning system (GPS) fix data

\$--GGA,hhmmss.ss,llll.lll,a,yyyyy.yyy,a,x,xx,x.x,x.x,M,x.x,M,x.x,xxxx\*hh<CR><LF>

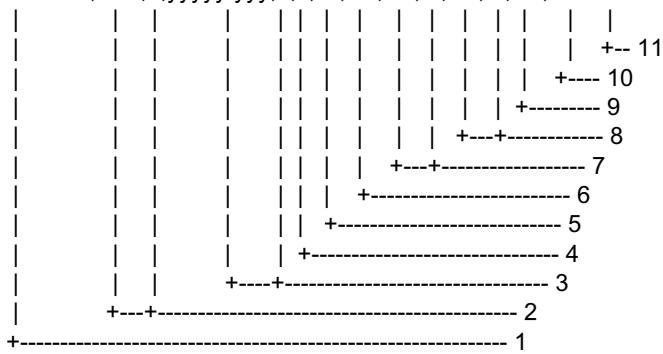

1. UTC of position
2. Latitude, N/S
3. Longitude, E/W
4. GPS quality indicator (see note)
5. Number of satellite in use,00-12, may be different from the number in view
6. Horizontal dilution of precision
7. Antenna altitude above/below mean sealevel, m
8. Geoidal separation, m
9. Age of differential GPS data
10. Differential reference station ID, 0000-1023
11. Checksum

### NOTE

- 0 = fix not available or invalid
- 1 = GPS SPS mode, fix valid
- 2 = differential GPS, SPS mode, fix valid
- 3 = GPS PPS mode, fix valid
- 4 = Real Time Kinetic. Satellite system used in RTK mode with fixed integers
- 5 = Float RTK. Satellite system used in RTK mode with floating fingers
- 6 = Estimated (dead reckoning) mode
- 7 = Manual input mode
- 8 = Simulator mode

The GPS quality indicator shall not be a null field.

## GLL - Geographic position - latitude and longitude

\$--GLL,III.III,a,yyyyy.yyy,a,hmmss.ss,A,a\*hh<CR><LF>

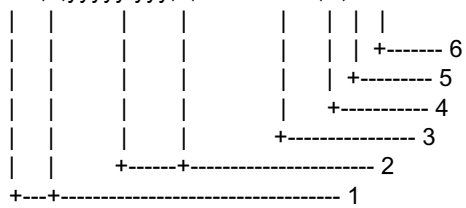

1. Latitude, N/S
2. Longitude, E/W
3. UTC of position
4. Status: A=data valid, V=data invalid
5. Mode indicator(see note)
6. Checksum

NOTE Positioning system Mode indicator:

- A = Autonomous
- D = Differential
- E = Estimated (dead reckoning)
- M = Manual input
- S = Simulator
- N = Data not valid

The Mode indicator field supplements the Status field. The Status field shall be set to V=invalid for all values of Operating Mode except for A=Autonomous and D=Differential. The positioning system Mode indicator and Status field shall not be null fields.

## MTW - Water temperature

\$--MTW,x.x,C\*hh<CR><LF>

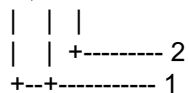

1. Temperature, degrees C
2. Checksum

## RMA - Recommended minimum navigation information - Loran C data

\$--RMA,A,lll,lll,a,yyyyy.yy,a,x.x,x.x,x.x,x.x,x.x,x.x,a\*hh<CR><LF>

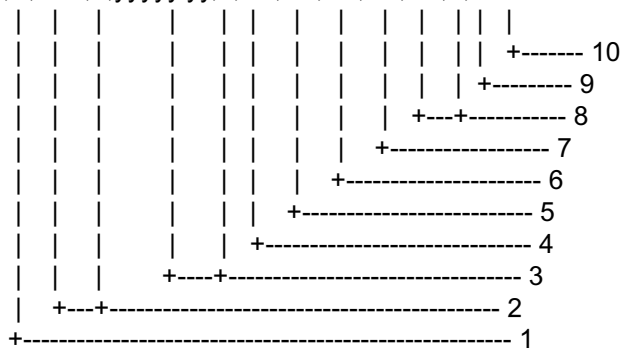

1. Status: A=data valid, V=blink, cycle or SNR warning
2. Latitude, degrees N/S
3. Longitude, degrees E/W
4. Time difference A, microseconds
5. Time difference B, microseconds
6. Speed over ground, knots
7. Course over ground, degrees true
8. Magnetic variation(see note 1),degree E/W
9. Mode indicator(see note 2)
10. Checksum

NOTE 1 - Easterly variation(E) subtracts from true course  
Westerly variation(W) adds to true course

NOTE 2 Positioning system Mode indicator:

- A = Autonomous
- D = Differential
- E = Estimated (dead reckoning)
- M = Manual input
- S = Simulator
- N = Data not valid

The Mode indicator field supplements the Status field. The Status field shall be set to V=invalid for all values of Operating Mode except for A=Autonomous and D=Differential. The positioning system Mode indicator and Status field shall not be null fields.



## RMB - Recommended minimum navigation information

\$--RMB,A,x.x,a,c--c,c--c,llll.lll,a,yyyyy.yyy,a,x.x,x.x,x.x,A,a\*hh<CR><LF>

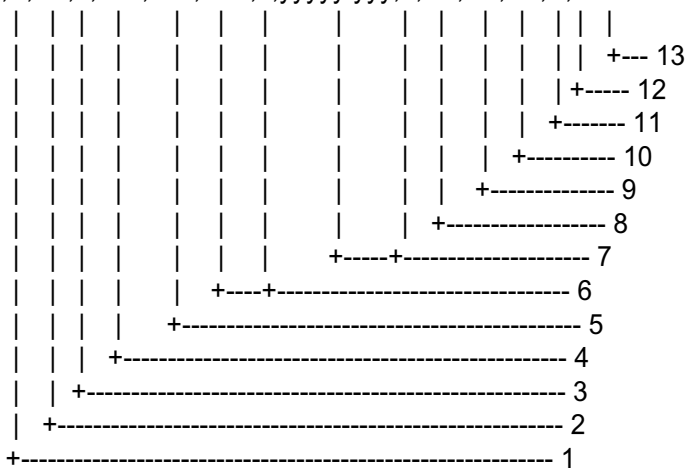

1. Data status: A=data valid, V=navigation receiver warning
2. Cross track error(see note 2) n.miles
3. Direction to steer L/R
4. Origin waypoint ID
5. Destination waypoint ID
6. Destination waypoint latitude,N/S
7. Destination waypoint longitude,E/W
8. Range to destination, n.miles(see note 1)
9. Bearing to destination, degrees true
10. Destination closing velocity, knots
11. Arrival status: A=arrival circle entered or perpendicular passed
12. Mode indicator(see note 3)
13. Checksum

### NOTES

- 1 If range to destination exceeds 999.9 nautical miles, display 999.9.
- 2 If cross track error exceeds 9.99 nautical miles, display 9.99.
- 3 Positioning system Mode indicator:
  - A = Autonomous
  - D = Differential
  - S = Simulator
  - N = Data not valid

The Mode indicator field supplements the Status field. The Status field shall be set to V=invalid for all values of Operating Mode except for A=Autonomous and D=Differential. The positioning system Mode indicator and Status field shall not be null fields.

## RMC - Recommended minimum navigation information - GPS/TRANSIT data

\$--RMC,hhmmss.ss,A,llll.lll,a,yyyyy.yyy,a,x.x,x.x,xxxxxx,x.x,a\*hh<CR><LF>

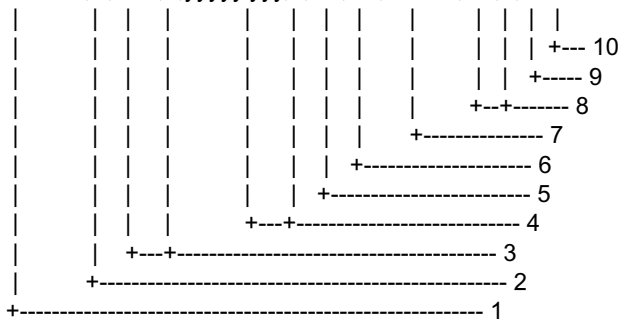

1. UTC of position fix
2. Status: A=data valid, V=navigation receiver warning
3. Latitude, N/S
4. Longitude, E/W
5. Speed over ground, knots
6. Course over ground, degrees true
7. Date: dd/mm/yy
8. magnetic variation, degrees E/W
9. Mode indicator(see note)
10. Checksum

NOTE Positioning system Mode indicator:

- A = Autonomous
- D = Differential
- E = Estimated (dead reckoning)
- M = Manual input
- S = Simulator
- N = Data not valid

The Mode indicator field supplements the Status field. The Status field shall be set to V=invalid for all values of Operating Mode except for A=Autonomous and D=Differential. The positioning system Mode indicator and Status field shall not be null fields.

## VDR - Set and drift

\$--VDR,x.x,T,x.x,M,x.x,N\*hh<CR><LF>

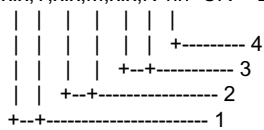

1. Direction, degrees true
2. Direction, degrees magnetic
3. Current speed, knots
4. Checksum

## VTG - Course over ground and ground speed

\$--VTG,x.x,T,x.x,M,x.x,N,x.x,K,a\*hh<CR><LF>

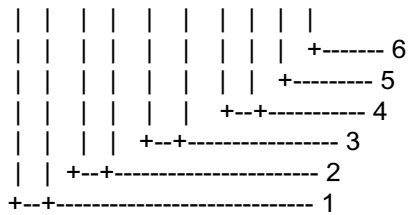

1. Course over ground, degrees true
2. Course over ground, degrees magnetic
3. Speed over ground, knots
4. Speed over ground, km/h
5. Mode indicator(see note)
6. Checksum

NOTE Positioning system Mode indicator:

- A = Autonomous
- D = Differential
- E = Estimated (dead reckoning)
- M = Manual input
- S = Simulator
- N = Data not valid

The positioning system Mode indicator field shall not be a null field.

## WPL - Waypoint location

\$--WPL,IIII.III,a,yyyyy.yyy,a,c--c\*hh<CR><LF>

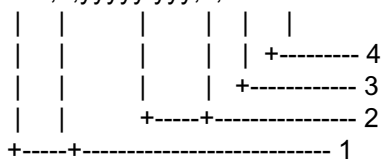

1. Waypoint latitude, N/S
2. Waypoint longitude, E/W
3. Waypoint identifier
4. Checksum

## ZDA - Date and time

\$--ZDA,hhmmss.ss,xx,xx,xxxx,xx,xx\*hh<CR><LF>

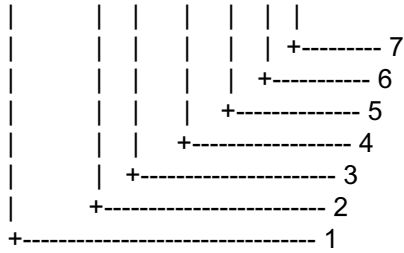

1. UTC
2. Day, 01 to 31(UTC)
3. Month, 01 to 12(UTC)
4. Year(UTC)
5. Local zone hours, 00h to +-13h
6. Local zone minutes, 00 to +59  
as local hours
7. Checksum

## Output sentences

**GGA, GLL, RMC, VTG, ZDA - See input sentences.**

**GSV - GNSS satellites in view**

\$--GSV,x,x,xx,xx,xx,xxx,xx.....,xx,xx,xxx,xx\*hh<CR><LF

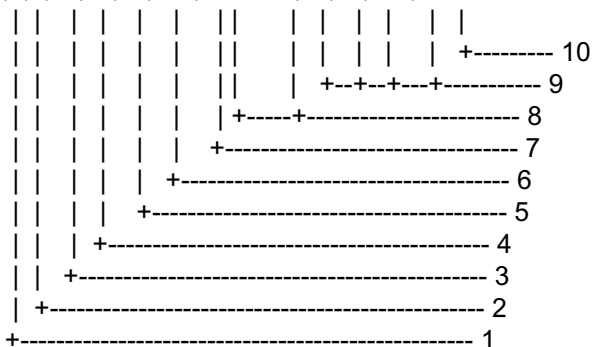

1. Total number of messages, 1 to 9
2. Message number, 1 to 9
3. Total number of satellites in view
4. Satellite ID number
5. Elevation, degrees, 90deg maximum
6. Azimuth, degrees true, 000 to 359
7. SNR(C/No) 00-99 dB-Hz, null when not tracking
8. Second and third SVs
9. Fourth SV
10. Checksum

# Index

## A

Address book ..... 2-22  
Addressee code ..... 3-2

## C

Cancel transmission ..... 4-13  
Change Window ..... 3-11  
Class 1/2/3 ..... 10  
Close ..... 3-9  
Combining Files ..... 3-14  
Communication network mode ..... 1-9  
Communication unit remarks ..... 1-10  
Communication unit status ..... 1-10  
Confidential message ..... 3-2  
Copy ..... 3-5  
Cut ..... 3-4

## D

Date and time display ..... 1-11  
Data report ..... 5-1  
DCE version number ..... 1-10  
Delete File ..... 3-14  
Delete message ..... 4-25  
Delivery status ..... 4-14, 4-16  
Directories ..... 2-27  
Display log ..... 4-26  
Display log description ..... 4-27  
Distress alert information ..... 1-9  
Distress communication ..... 6-5  
DNID ..... 5-9

## E

E-mail Service List ..... 2-28  
Editor menu ..... 3-3  
EGC channels ..... 2-15  
EGC message ..... 4-28  
EGC setup ..... 2-11  
ENID ..... 4-29  
Entering Own Ship's Position ..... 2-26

## F

FleetNET™ ..... 5, 2-11  
Format ..... 3-7  
Frame synchronization ..... 1-10

## G

General utility ..... 4-18

## I

Insert ..... 3-6  
IA5 ..... 4-1  
ITA2 ..... 4-1

## L

Land Earth Stations(LES) ..... 7  
LES List ..... 2-18  
Log ..... 4-26  
Logging status ..... 1-11

## M

Maritime safety service ..... 4-18  
Message report ..... 5-4  
Message status list description ..... 4-15  
MIME ..... 3-15  
Mobile Earth Stations(MES) ..... 7

## N

NCS Channel ..... 2-16, 7-4  
Network Coordination Stations(NCS) ..... 7

## O

Ocean Region ..... 2-24  
Ocean region receiving ..... 1-10  
Open File ..... 3-10  
Other information ..... 1-11

## P

Password ..... 3-2  
Paste ..... 3-4  
Polling ..... 5-6  
Print ..... 3-13

## R

Receive alarm ..... 4-21  
Distress/Urgent Receiving unit ..... 4-26  
Receiving ..... 4-20  
ROM disk ..... 4-25

## S

SafetyNET™ ..... 5, 2-11  
Save message ..... 3-8  
Send status ..... 4-14  
Ship's position ..... 1-11  
SPEC ..... 2-23  
Station List ..... 2-22

## T

Transmit message status ..... 4-9  
Two-digit code ..... 4-17

**FURUNO****FURUNO ELECTRIC CO., LTD.**9-52 Ashihara-Cho, Nishinomiya City, 662-8580, Hyogo, Japan  
Tel: +81 798-65-2111 Fax: +81 798-65-4200

Pub NO. DOC-505

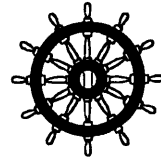
**Declaration of conformity****0560**We FURUNO ELECTRIC CO., LTD.

(Manufacturer)

9-52 Ashihara-Cho, Nishinomiya City, 662-8580, Hyogo, Japan

(Address)

hereby declare under our sole responsibility that the product

Inmarsat-C satellite earth station models FELCOM 12 consisting of Communication unit IC-212 (with built-in GPS receiver module OP16-16-2), Antenna unit IC-112, Distress alert unit IC-302, Received call unit IC-303, Printer PP-510 and Terminal unit IB-581 or IB-582

(Model names, type numbers)

to which this declaration relates conforms to the following standard(s) or normative document(s)

StandardsIMO Resolution MSC.36(63)  
IMO Resolutions A.570(14), A.664(16), A.807(19)  
IMO Resolution A.694(17)  
IMO MSC Circular MSC/Circ.862Test standardsIEC 61097-4: 1994-11  
EN 60945: 1997-01 (IEC 60945 Ed.03: 1996-11)  
IEC 61162-1: 2000-07

(title and/or number and date of issue of the standard(s) or other normative document(s))

For assessment, see

- EC type-examination certificate N°: 99212008/AA/02 of 11 November 2002 issued by Telefication, The Netherlands
- Test report 97384530 of 28 January 1998 issued by Telefication, The Netherlands
- Test report 98508030 of 23 June 1999 issued by KTL, The Netherlands

This declaration is issued according to the provisions of European Council Directive 96/98/EC on marine equipment modified by Commission Directive 2002/75/EC.

On behalf of Furuno Electric Co., Ltd.

Hiroaki Komatsu  
Manager,  
International Rules and RegulationsNishinomiya City, Japan  
January 15, 2003

(Place and date of issue)

(name and signature or equivalent marking of authorized person)